

PRODUCT MONOGRAPH
INCLUDING PATIENT MEDICATION INFORMATION

PrAIMOVIG®
(erenumab injection)

Solution for Injection, 70 mg/mL, for subcutaneous use

Solution for Injection, 140 mg/mL, for subcutaneous use

Professed Standard

Anti-Calcitonin gene-related peptide receptor (anti-CGRPR)

Novartis Pharmaceuticals Canada Inc.
700 Saint-Hubert St., Suite 100
Montreal, Quebec
H2Y 0C1

Date of Initial Authorization:
August 01, 2018

Date of Revision:
October 27, 2022

Novartis Version:
April 04, 2023

Submission Control Number: 264464

® AIMOVIG & SureClick are registered trademarks of Amgen Inc. used under license by
Novartis Pharmaceuticals Canada Inc.

RECENT MAJOR LABEL CHANGES

7.0 WARNINGS AND PRECAUTIONS, Constipation with Serious Complications	09/2022
---	---------

TABLE OF CONTENTS

Sections or subsections that are not applicable at the time of authorization are not listed.

RECENT MAJOR LABEL CHANGES	2
TABLE OF CONTENTS	2
PART I: HEALTH PROFESSIONAL INFORMATION	4
1 INDICATIONS	4
1.1 Pediatrics	4
1.2 Geriatrics	4
2 CONTRAINDICATIONS	4
4 DOSAGE AND ADMINISTRATION	4
4.1 Dosing Considerations	4
4.2 Recommended Dose and Dosage Adjustment	4
4.4 Administration	5
4.5 Missed Dose	5
5 OVERDOSAGE	5
6 DOSAGE FORMS, STRENGTHS, COMPOSITION AND PACKAGING	5
7 WARNINGS AND PRECAUTIONS	6
7.1 Special Populations	7
7.1.1 Pregnant Women	7
7.1.2 Breast-feeding	7
7.1.3 Pediatrics	8
7.1.4 Geriatrics	8
8 ADVERSE REACTIONS	8
8.1 Adverse Reaction Overview	8
8.2 Clinical Trial Adverse Reactions	9
8.2.1 Clinical Trial Adverse Reactions – Pediatrics	14

8.3	Less Common Clinical Trial Adverse Reactions.....	14
8.5	Post-Market Adverse Reactions.....	15
9	DRUG INTERACTIONS	15
9.2	Drug Interactions Overview	15
9.4	Drug-Drug Interactions	15
9.5	Drug-Food Interactions.....	16
9.6	Drug-Herb Interactions	16
9.7	Drug-Laboratory Test Interactions.....	16
10	CLINICAL PHARMACOLOGY.....	16
10.1	Mechanism of Action	16
10.2	Pharmacodynamics.....	16
10.3	Pharmacokinetics.....	16
11	STORAGE, STABILITY AND DISPOSAL.....	18
12	SPECIAL HANDLING INSTRUCTIONS.....	18
	PART II: SCIENTIFIC INFORMATION	19
13	PHARMACEUTICAL INFORMATION	19
14	CLINICAL TRIALS	19
14.1	Trial Design and Study Demographics Clinical Trials by Indication	19
	Migraine Prevention	19
14.2	Comparative Bioavailability Studies	24
14.3	Immunogenicity	25
15	MICROBIOLOGY	26
16	NON-CLINICAL TOXICOLOGY	26
	PATIENT MEDICATION INFORMATION	27
	PATIENT MEDICATION INFORMATION	39

PART I: HEALTH PROFESSIONAL INFORMATION

1 INDICATIONS

AIMOVIG® (erenumab injection) is indicated for:

- prevention of migraine in adults who have at least 4 migraine days per month

1.1 Pediatrics

Pediatrics (< 18 years of age): Safety and efficacy of Aimovig in patients below the age of 18 have not been studied. Aimovig is not authorized for pediatric use.

1.2 Geriatrics

Geriatrics (≥ 65 years of age): Safety and efficacy of Aimovig has not been studied in patients aged 65 or older. See [7.1.4 Geriatrics](#).

2 CONTRAINDICATIONS

- Aimovig is contraindicated in patients who are hypersensitive to this drug or to any ingredient in the formulation, including any non-medicinal ingredient, or component of the container. For a complete listing, see [6 DOSAGE FORMS, STRENGTHS, COMPOSITION AND PACKAGING](#).

4 DOSAGE AND ADMINISTRATION

4.1 Dosing Considerations

- Aimovig is administered subcutaneously through single-dose pre-filled autoinjector or single-dose pre-filled syringe.
- Aimovig is intended for patient self-administration.
- Administration should be performed by an individual who has been trained to administer the product
- Aimovig should be initiated by health professionals experienced in the diagnosis and treatment of migraine.

4.2 Recommended Dose and Dosage Adjustment

The recommended dose of Aimovig is 70 mg administered once monthly. Some patients may benefit from a dose of 140 mg once monthly administered as one subcutaneous injection of 140 mg. See [Part II- 14 CLINICAL TRIALS](#).

Aimovig is not approved for pediatric use.

4.4 Administration

To administer the recommended dose of 70 mg, give one subcutaneous injection. To administer the recommended dose of 140 mg, give one subcutaneous injection of 140 mg.

Prior to subcutaneous administration, allow Aimovig to sit at room temperature for at least 30 minutes and protect from direct sunlight. Do not warm by using a heat source such as hot water or microwave.

Do not shake the product.

Visually inspect the solution for particles and discolouration. Aimovig is a clear to opalescent, colourless to light yellow solution. Do not use if the solution is cloudy, discoloured or if flakes or particles are present.

Administer Aimovig subcutaneously in the abdomen, thigh, or upper arm. Injection sites should be rotated and injections should not be given into areas where the skin is tender, bruised, red, or hard.

Both the pre-filled syringe and the pre-filled SureClick® autoinjector are single-dose and designed to deliver the entire contents with no residual content.

The grey needle cover of the Aimovig pre-filled syringe and the needle shield within the white or orange cap of the Aimovig pre-filled autoinjector contains dry natural rubber (a derivative of latex), which may cause allergic reactions in individuals sensitive to latex.

Comprehensive instructions for the administration of Aimovig are provided in the Patient Medication Information.

4.5 Missed Dose

If an Aimovig dose is missed, administer as soon as possible. Thereafter, Aimovig can be scheduled monthly from the date of the last dose.

5 OVERDOSAGE

There are no reported events of overdose in clinical trials with Aimovig and data regarding overdosage are unavailable. Doses up to 280 mg subcutaneously have been administered in clinical trials with no evidence of dose limiting toxicity.

In the event of an overdose, the patient should be treated symptomatically and supportive measures instituted as required.

For management of a suspected drug overdose, contact your regional poison control centre.

6 DOSAGE FORMS, STRENGTHS, COMPOSITION AND PACKAGING

To help ensure the traceability of biologic products, including biosimilars, health professionals should recognise the importance of recording both the brand name and the non-proprietary (active ingredient) name as well as other product-specific identifiers such as the Drug

Identification Number (DIN) and the batch/lot number of the product supplied.

Table 1 – Dosage Forms, Strengths, Composition and Packaging

Route of Administration	Dosage Form / Strength/Composition	Non-medicinal Ingredients
Subcutaneous injection	Solution for injection in Pre-filled syringe and Pre-filled autoinjector / 70 mg per mL and 140 mg per mL	Glacial acetic acid, Polysorbate 80, Sucrose, Water for injection. Sodium hydroxide may have been used to adjust the pH to 5.2.

Aimovig is a clear to opalescent, colourless to light yellow sterile, preservative-free solution, practically free from particles.

The grey needle cover of the glass pre-filled syringe and the needle shield within the white or orange cap of the pre-filled autoinjector is made from dry natural rubber (a derivative of latex).

Aimovig is available in a carton containing either:

- One 70 mg/mL pre-filled syringe*, delivering one dose totalling 70 mg.
- One 140 mg/mL pre-filled syringe*, delivering one dose totalling 140 mg.
- One 70 mg/mL pre-filled SureClick autoinjector, delivering one dose totalling 70 mg.
- One 140 mg/mL pre-filled SureClick autoinjector, delivering one dose totalling 140 mg.

*Pre-filled syringes are not available in Canada.

7 WARNINGS AND PRECAUTIONS

Constipation with Serious Complications

Constipation with serious complications has been reported following the use of Aimovig in the postmarketing setting. There were cases that required hospitalization, including cases where surgery was necessary. In a majority of these cases, the onset of constipation was reported after the first dose of Aimovig; however, patients have also presented with constipation later on in treatment. Aimovig was discontinued in most reported cases of constipation with serious complications. Constipation was one of the most common (up to 4.3%) adverse reactions reported in clinical studies. See section [8.2 Clinical Trial Adverse Reactions](#).

Monitor patients treated with Aimovig for severe constipation and manage as clinically appropriate. A history of constipation or the concurrent use of medications associated with decreased gastrointestinal motility may increase the risk for more severe constipation and the potential for constipation-related complications. Advise patients to seek medical attention if they develop severe constipation.

Driving and Operating Machinery

No data are available to evaluate the effect of Aimovig on driving and operating machinery. Aimovig is expected to have no influence on the ability to drive and use machines.

Sensitivity

Hypersensitivity Reactions

Serious hypersensitivity reactions, including rash, angioedema, and anaphylactoid reactions, have been reported with Aimovig in post-marketing experience. These reactions may occur within minutes, although some may occur more than one week after treatment. If a serious or severe hypersensitivity reaction occurs, discontinue administration of Aimovig and initiate appropriate therapy. See [2 CONTRAINDICATIONS](#).

Reproductive Health: Female and Male Potential

- **Fertility**

No data are available on the effect of Aimovig on human fertility. No dedicated fertility studies have been conducted in animals; however, there were no histopathological changes in male or female reproductive organs in a study conducted in sexually mature monkeys at systemic exposures up to 123-fold higher than that predicted for the maximum recommended human dose of 140 mg once monthly. See [16 NON-CLINICAL TOXICOLOGY](#).

7.1 Special Populations

7.1.1 Pregnant Women

There are no adequate and well-controlled studies on the use of Aimovig in pregnant women.

In a cynomolgus monkey developmental study, there were no effects on pregnancy or on embryo-fetal and post-natal development (up to 6 months age) when erenumab was administered every two weeks from gestation day 20-22 to parturition at an exposure level 17-fold higher than that predicted for the maximum recommended clinical dose of 140 mg once monthly. Measurable erenumab serum concentrations were observed in the infant monkeys at birth, confirming that erenumab, like other IgG antibodies, crosses the placental barrier. See [16 NON-CLINICAL TOXICOLOGY](#).

Animal studies are not always predictive of human response and therefore, it is unknown whether Aimovig can cause fetal harm when administered to a pregnant woman. Because IgG antibodies cross the placenta, avoid the use of Aimovig during pregnancy as a precautionary measure.

7.1.2 Breast-feeding

It is unknown if Aimovig is excreted in human milk. Because antibodies are excreted in human milk, caution should be exercised. There are no data on the effects of Aimovig on the breastfed child or the effects of Aimovig on milk production. A decision should be made whether to discontinue nursing or discontinue Aimovig, taking into account the potential benefit of Aimovig to the mother and the potential benefit of breast feeding to the infant.

7.1.3 Pediatrics

Pediatrics (< 18 years of age): The safety and effectiveness of Aimovig has not been studied in pediatric patients. Aimovig is not authorized for pediatric use.

7.1.4 Geriatrics

No data are available for patients aged 65 years and older.

8 ADVERSE REACTIONS

8.1 Adverse Reaction Overview

A total of over 2,500 patients (more than 2,600 patient years) have been treated with AIMOVIG in registration studies. Of these, more than 1,300 patients were exposed for at least 12 months.

The adverse reactions reported in the placebo-controlled trials of Aimovig were injection site reactions, constipation, muscle spasm and pruritus.

Table 1 Adverse Reactions Reported with Aimovig-treated Patients (and More Frequently than in Patients Receiving Placebo) by System Organ Class and Preferred Term

System Organ Class Preferred Term	Aimovig 70 mg N = 893 n (%)	Aimovig 140 mg N = 507 n (%)	Placebo N = 1043 n (%)
General disorders and administration site conditions			
Injection site reactions ^a	50 (5.6%)	23 (4.5%)	33 (3.2%)
Gastrointestinal disorders			
Constipation	12 (1.3%)	16 (3.2%)	11 (1.1%)
Musculoskeletal and connective tissue disorders			
Muscle spasm	1 (0.1%)	10 (2.0 %)	4 (0.4%)
Skin and subcutaneous tissue disorders			
Pruritus ^b	6 (0.7%)	9 (1.8%)	5 (0.5%)

System Organ Class Preferred Term	Aimovig 70 mg N = 893 n (%)	Aimovig 140 mg N = 507 n (%)	Placebo N = 1043 n (%)
<p>^a Injection Site Reactions includes multiple preferred terms, such as injection site pain and injection site erythema.</p> <p>^b Pruritus includes generalized pruritus, pruritus, and pruritic rash.</p>			

8.2 Clinical Trial Adverse Reactions

Clinical trials are conducted under very specific conditions. The adverse reaction rates observed in the clinical trials; therefore, may not reflect the rates observed in practice and should not be compared to the rates in the clinical trials of another drug. Adverse reaction information from clinical trials may be useful in identifying and approximating rates of adverse drug reactions in real-world use.

In the 12 week placebo-controlled period, one grade 3 (0.2%) muscle spasm was reported in subjects treated with Aimovig 140 mg. This subject had a history of muscle spasms and experienced worsening of back spasms. All other adverse reactions were grade 1 (mild) or moderate (grade 2) in severity.

In the pivotal studies, the following adverse events were observed to occur at or above 1% during the double-blind treatment phase.

Table 3 Incidence of Treatment-emergent Adverse Events in ≥ 1% of Subjects in either Aimovig Group (70 mg or 140 mg) in Study 20120295

System Organ Class Preferred Term	Aimovig 70 mg (N=190) n (%)	Aimovig 140 mg (N=188) n (%)	Placebo (N=282) n (%)
Cardiac disorders			
Palpitations	1 (0.5)	2 (1.1)	2 (0.7)
Ear and labyrinth disorders			
Tinnitus	2 (1.1)	1 (0.5)	0
Eye disorders			
Eye irritation	2 (1.1)	0	0

System Organ Class Preferred Term	Aimovig 70 mg (N=190) n (%)	Aimovig 140 mg (N=188) n (%)	Placebo (N=282) n (%)
Gastrointestinal disorders			
Nausea	4 (2.1)	6 (3.2)	7 (2.5)
Constipation	0	8 (4.3)	1 (0.4)
Diarrhea	2 (1.1)	4 (2.1)	4 (1.4)
Dyspepsia	2 (1.1)	2 (1.1)	2 (0.7)
Abdominal pain upper	2 (1.1)	1 (0.5)	2 (0.7)
Toothache	2 (1.1)	1 (0.5)	2 (0.7)
General disorders and administration site conditions			
Injection site pain	7 (3.7)	7 (3.7)	3 (1.1)
Injection site erythema	1 (0.5)	6 (3.2)	0
Fatigue	2 (1.1)	4 (2.1)	5 (1.8)
Administration site pain	2 (1.1)	1 (0.5)	0
Influenza like illness	2 (1.1)	1 (0.5)	2 (0.7)
Injection site pruritus	0	2 (1.1)	0
Infections and infestations			
Upper respiratory tract infection	5 (2.6)	6 (3.2)	4 (1.4)
Nasopharyngitis	6 (3.2)	3 (1.6)	16 (5.7)
Influenza	4 (2.1)	1 (0.5)	0
Sinusitis	3 (1.6)	2 (1.1)	6 (2.1)
Urinary tract infection	3 (1.6)	2 (1.1)	3 (1.1)
Bronchitis	2 (1.1)	2 (1.1)	1 (0.4)
Pharyngitis	3 (1.6)	1 (0.5)	2 (0.7)
Rhinitis	0	4 (2.1)	1 (0.4)
Viral infection	1 (0.5)	2 (1.1)	2 (0.7)
Appendicitis	2 (1.1)	0	0
Injury, poisoning and procedural complications			

System Organ Class Preferred Term	Aimovig 70 mg (N=190) n (%)	Aimovig 140 mg (N=188) n (%)	Placebo (N=282) n (%)
Contusion	0	2 (1.1)	2 (0.7)
Metabolism and nutrition disorders			
Decreased appetite	2 (1.1)	0	0
Hyperlipidemia	0	2 (1.1)	0
Musculoskeletal and connective tissue disorders			
Muscle spasms	1 (0.5)	7 (3.7)	4 (1.4)
Arthralgia	2 (1.1)	1 (0.5)	3 (1.1)
Back pain	1 (0.5)	2 (1.1)	4 (1.4)
Myalgia	2 (1.1)	1 (0.5)	2 (0.7)
Flank pain	0	2 (1.1)	0
Pain in extremity	0	2 (1.1)	2 (0.7)
Nervous system disorders			
Migraine	3 (1.6)	5 (2.7)	3 (1.1)
Dizziness	3 (1.6)	2 (1.1)	3 (1.1)
Hypoaesthesia	3 (1.6)	2 (1.1)	0
Cervicobrachial syndrome	0	2 (1.1)	0
Disturbance in attention	2 (1.1)	0	0
Paraesthesia	0	2 (1.1)	3 (1.1)
Psychiatric disorders			
Insomnia	2 (1.1)	3 (1.6)	0
Respiratory, thoracic and mediastinal disorders			
Oropharyngeal pain	4 (2.1)	3 (1.6)	0
Cough	1 (0.5)	5 (2.7)	2 (0.7)
Epistaxis	3 (1.6)	0	0

System Organ Class Preferred Term	Aimovig 70 mg (N=190) n (%)	Aimovig 140 mg (N=188) n (%)	Placebo (N=282) n (%)
Nasal congestion	1 (0.5)	2 (1.1)	3 (1.1)
Rhinorrhea	1 (0.5)	2 (1.1)	0
Dyspnea	2 (1.1)	0	1 (0.4)
Skin and subcutaneous tissue disorders			
Alopecia	1 (0.5)	2 (1.1)	0
Rash	0	3 (1.6)	0
Pruritus generalized	0	2 (1.1)	1 (0.4)
Vascular disorders			
Hot flush	1 (0.5)	3 (1.6)	1 (0.4)

Table 4 Incidence of Treatment-emergent Adverse Events in $\geq 1\%$ of Subjects in either Aimovig Group (70 mg or 140 mg) in Study 20120296

System Organ Class Preferred Term	Aimovig 70 mg (N=314) n (%)	Aimovig 140 mg (N=319) n (%)	Placebo (N=319) n (%)
Gastrointestinal disorders			
Constipation	6 (1.9)	12 (3.8)	4 (1.3)
Nausea	7 (2.2)	6 (1.9)	6 (1.9)
Vomiting	5 (1.6)	5 (1.6)	6 (1.9)
Abdominal Pain upper	3 (1.0)	5 (1.6)	3 (0.9)
General disorders and administration site conditions			
Fatigue	6 (1.9)	7 (2.2)	8 (2.5)
Injection site pain	10 (3.2)	2 (0.6)	1 (0.3)
Injection site erythema	6 (1.9)	5 (1.6)	2 (0.6)
Injection site pruritus	4 (1.3)	2 (0.6)	0

System Organ Class Preferred Term	Aimovig 70 mg (N=314) n (%)	Aimovig 140 mg (N=319) n (%)	Placebo (N=319) n (%)
Pyrexia	4 (1.3)	0	4 (1.3)
Infections and infestations			
Viral upper respiratory tract infection	32 (10.2)	39 (12.2)	34 (10.7)
Upper respiratory tract infection	21 (6.7)	15 (4.7)	19 (6.0)
Sinusitis	7 (2.2)	11 (3.4)	7 (2.2)
Influenza	4 (1.3)	10 (3.1)	5 (1.6)
Urinary tract infection	5 (1.6)	7 (2.2)	7 (2.2)
Bronchitis	5 (1.6)	6 (1.9)	2 (0.6)
Gastroenteritis viral	4 (1.3)	5 (1.6)	0
Ear infection	4 (1.3)	1 (0.3)	1 (0.3)
Musculoskeletal and connective tissue disorders			
Arthralgia	7 (2.2)	7 (2.2)	6 (1.9)
Back pain	6 (1.9)	7 (2.2)	6 (1.9)
Osteoarthritis	4 (1.3)	3 (0.9)	2 (0.6)
Neck pain	1 (0.3)	4 (1.3)	1 (0.3)
Pain in extremity	4 (1.3)	1 (0.3)	5 (1.6)
Nervous system disorders			
Dizziness	2 (0.6)	6 (1.9)	5 (1.6)
Headache	4 (1.3)	3 (0.9)	3 (0.9)
Migraine	4 (1.3)	3 (0.9)	10 (3.1)
Psychiatric disorders			
Insomnia	1 (0.3)	4 (1.3)	5 (1.6)
Skin and subcutaneous tissue disorders			

System Organ Class Preferred Term	Aimovig 70 mg (N=314) n (%)	Aimovig 140 mg (N=319) n (%)	Placebo (N=319) n (%)
Pruritus	5 (1.6)	3 (0.9)	4 (1.3)
Pruritus generalized	0	4 (1.3)	0
Vascular disorders			
Hypertension	6 (1.9)	0	7 (2.2)

Injection site reactions

In the integrated 12-week placebo controlled period of studies, in subjects treated with Aimovig the most frequent injection site reactions were injection site pain, injection site erythema, and injection site pruritus. A majority of injection site reactions were mild in severity.

Constipation

In the integrated 12-week placebo-controlled period of studies, 28 cases of constipation were reported out of 1,400 Aimovig-treated patients. All constipation events were mild or moderate in severity. There were no serious events. A majority of the cases (23) had onset within one month after the first dose; however, some patients also presented with constipation later on in treatment. In most cases (18), constipation resolved within three months. All but one case continued treatment.

Muscle spasms

In the integrated 12-week placebo controlled period of studies, majority of muscle spasms were mild or moderate in severity. There were no serious events.

Pruritus

In the integrated 12-week placebo controlled period of studies, the most frequent pruritus was generalized pruritus. All pruritus events were mild or moderate in severity. There were no serious events.

8.2.1 Clinical Trial Adverse Reactions – Pediatrics

The safety and efficacy of Aimovig has not been studied in pediatric patients.

8.3 Less Common Clinical Trial Adverse Reactions

None.

8.5 Post-Market Adverse Reactions

Immune system disorders

- Hypersensitivity reactions including rash, angioedema and anaphylactoid reactions. See [7 WARNINGS AND PRECAUTIONS](#). Most hypersensitivity reactions were not serious and occurred within hours of administration, although some occurred more than one week after administration. If a serious or severe hypersensitivity reaction occurs, discontinue administration of Aimovig and initiate appropriate therapy.

Gastrointestinal disorders

- Constipation with serious complications has been reported. See [7 WARNINGS AND PRECAUTIONS](#). In a majority of these cases, the onset was reported after the first dose of Aimovig; however patients have also experienced these events later on in the treatment. Many of the cases of constipation with serious complications were reported for patients who have a history of constipation or concurrently use medications associated with decreased gastrointestinal motility. In some severe cases hospitalization was required.
- Oral sores (e.g., stomatitis, mouth ulceration, oral mucosal blistering)

Skin and subcutaneous tissue disorders

- Alopecia
- Rash (e.g., rash papular, exfoliative rash, rash erythematous, urticaria, blister)

9 DRUG INTERACTIONS

9.2 Drug Interactions Overview

Erenumab is not metabolized by cytochrome P450 enzymes; therefore, interactions with concomitant medications that are substrates, inducers, or inhibitors of cytochrome P450 enzymes are unlikely.

9.4 Drug-Drug Interactions

Oral Contraceptive

In an open-label study, in healthy female subjects, a single subcutaneous 140 mg dose of erenumab did not affect the pharmacokinetics of a combined oral contraceptive containing ethinyl estradiol and norgestimate.

Sumatriptan

In a randomized, double-blind, placebo-controlled study in healthy subjects, concomitant administration of a single intravenous 140 mg dose of erenumab with two subcutaneous 6 mg doses of sumatriptan (separated by one hour) had no effect on the pharmacokinetics of sumatriptan and resting blood pressure compared with administration of sumatriptan alone. Aimovig is for subcutaneous use only.

9.5 Drug-Food Interactions

Interactions with food have not been studied.

9.6 Drug-Herb Interactions

Interactions with herbal products have not been studied.

9.7 Drug-Laboratory Test Interactions

Interference of Aimovig with laboratory and/or diagnostic tests has not been studied.

10 CLINICAL PHARMACOLOGY

10.1 Mechanism of Action

Erenumab is a recombinant human monoclonal antibody that competes with CGRP for binding to the CGRP receptor and antagonizes CGRP receptor function. It has no significant activity at adrenomedullin, calcitonin, and amylin receptors.

CGRP is a neuropeptide that modulates nociceptive signaling and a vasodilator that has been associated with migraine pathophysiology.

10.2 Pharmacodynamics

In a study in healthy subjects, concomitant administration of erenumab with sumatriptan had no effect on resting blood pressure compared with administration of sumatriptan alone. See [9.4 Drug-Drug Interactions](#).

10.3 Pharmacokinetics

Erenumab exhibits non-linear kinetics as a result of binding to the CGRP receptor.

Erenumab exposure demonstrated approximate dose proportionality from 70 mg to 140 mg following a single subcutaneous administration of erenumab. The C_{max} and AUC_{last} values following a single subcutaneous administration of 70 mg or 140 mg erenumab in healthy subjects are included in Table 5.

Following multiple subcutaneous administrations of erenumab once monthly to healthy and migraine subjects, the accumulation ratio was estimated to be less than 2-fold. The trough serum concentrations (C_{min}) for episodic and chronic migraine patients following subcutaneous administration of 70 mg once monthly and 140 mg once monthly doses are included in Table 5.

Based on population pharmacokinetics modeling, the effective half-life of Aimovig is 28 days.

Table 5 Pharmacokinetic Parameters of Aimovig

		Aimovig 70 mg	Aimovig 140 mg
Healthy subjects Single dose	C_{max} mean (SD)	6.1 (2.1) mcg/mL	15.8 (4.8) mcg/mL
	AUC_{last} mean (SD)	159 (58)	505 (139)

		day*mcg/mL	day*mcg/mL
Migraine patients Multiple doses	C _{min} mean (SD)		
	Episodic migraine	5.7 (3.1) mcg/mL	12.8 (6.5) mcg/mL
	Chronic migraine	6.2 (2.9) mcg/mL	14.9 (6.5) mcg/mL

Absorption

Following a single subcutaneous dose of 70 mg or 140 mg Aimovig administered to healthy subjects, median peak serum concentrations were attained in 4 to 6 days. Absolute bioavailability was estimated to be 82% based on population pharmacokinetic analysis.

Distribution

Following a single 140 mg intravenous dose in healthy subjects, the mean (SD) volume of distribution during the terminal phase (V_z) was estimated to be 3.86 (0.77) L.

Metabolism and Elimination

Two elimination phases were observed for Aimovig. At low concentrations, the elimination is predominantly through saturable binding to target (CGRP receptor), while at higher concentrations the elimination of Aimovig is largely through a non-specific, non-saturable proteolytic pathway.

Special Populations and Conditions

The pharmacokinetics of erenumab were not affected by age, gender, race, migraine subtype (episodic or chronic migraine) based on population pharmacokinetic analysis.

- **Hepatic Insufficiency:** No clinical studies have been conducted to evaluate the effect of hepatic impairment on the pharmacokinetics of Aimovig. The liver is not thought to be a major contributor toward the metabolism of Aimovig, an IgG2 antibody, to an appreciable degree.
- **Renal Insufficiency:** No clinical studies have been conducted to evaluate the effect of renal impairment on the pharmacokinetics of Aimovig. Population pharmacokinetic analysis of integrated data from the Aimovig clinical trials did not reveal a difference in the pharmacokinetics of erenumab in patients with mild or moderate renal impairment relative to those with normal renal function. Based on the population pharmacokinetic analysis, no dose adjustment is necessary in patients with mild to moderate renal impairment. Patients with severe renal impairment (eGFR < 30 mL/min/1.73 m²) have not been studied.

11 STORAGE, STABILITY AND DISPOSAL

Store refrigerated at 2°C to 8°C in the original carton to protect from light until time of use.

If removed from the refrigerator, Aimovig should be kept at controlled room temperature (up to 25°C) in the original carton and must be used within 7 days. Throw away Aimovig that has been left at room temperature for more than 7 days.

Do not freeze. Do not shake.

12 SPECIAL HANDLING INSTRUCTIONS

Any unused product or waste material should be disposed of in accordance with local requirements.

PART II: SCIENTIFIC INFORMATION

13 PHARMACEUTICAL INFORMATION

Drug Substance

Proper name:	erenumab
Chemical name:	anti-Calcitonin gene-related peptide receptor (anti-CGRPR) recombinant Human IgG2 monoclonal antibody
Molecular formula and molecular mass:	Erenumab has an approximate molecular weight of 150 kDa. Molecular formula: C ₆₄₇₂ H ₉₉₆₄ N ₁₇₂₈ O ₂₀₁₈ S ₅₀ (peptide)
Structural formula:	Erenumab is composed of 2 heavy chains, each containing 456 amino acids and with 4 intrachain disulfide bonds, as well as, 2 light chains of the lambda subclass, each containing 216 amino acids and with 2 intrachain disulfide bonds.
Physicochemical properties:	Aimovig is supplied as a sterile, preservative free solution of erenumab for subcutaneous administration. The solution of Aimovig is clear to opalescent and colourless to light yellow, with a pH of 5.2.
Pharmaceutical standard:	Professed Standard

Product Characteristics:

Aimovig (erenumab) is an anti-calcitonin gene-related peptide receptor fully human IgG2 monoclonal antibody expressed in a Chinese hamster ovary (CHO) cell line. Erenumab is produced by recombinant DNA technology in a mammalian cell expression system and is purified by a process that includes specific viral inactivation and removal steps.

14 CLINICAL TRIALS

14.1 Trial Design and Study Demographics Clinical Trials by Indication

Migraine Prevention

Aimovig was evaluated for prevention of migraine in two pivotal studies across the spectrum of episodic and chronic migraine (Table 6). Both studies enrolled patients with a history of migraine, with or without aura according to the International Classification of Headache Disorders (ICHD-III) diagnostic criteria. Patients with preexisting myocardial infarction, stroke, transient ischemic attacks, unstable angina, coronary artery bypass surgery or other revascularization procedures within 12 months prior to screening were excluded. Patients with poorly controlled hypertension or BMI >40 were excluded from Study 20120295.

Table 6 Summary of Trial Design and Patient Demographics for Clinical Trials in Migraine Prevention

Study #	Trial Design	Dosage, Route of Administration and Duration	Study Subjects (n)	Mean Age (Range)	Sex (Female)
20120295	Randomized, double-blind, placebo-controlled Efficacy and Safety in Chronic Migraine Prevention	Aimovig 140 mg SC QM	190	42.9 (18-64)	84.2%
		Aimovig 70 mg SC QM	191	41.4 (18-64)	86.9%
		Placebo SC QM	286	42.1 (18-66)	79.0%
		Duration: 12 weeks			
20120296 (STRIVE)	Randomized, double-blind, placebo-controlled Efficacy and Safety in Episodic Migraine Prevention	Aimovig 140 mg SC QM	319	40.4 (19-65)	85.3%
		Aimovig 70 mg SC QM	317	41.1 (18-63)	84.5%
		Placebo SC QM	319	41.3 (18-65)	85.9%
		Duration: 24 weeks			

QM = once monthly; SC = subcutaneously

Chronic Migraine

Aimovig was evaluated for prevention of chronic migraine in a pivotal phase 2 randomized, multi-centre, 12-week, placebo-controlled, double-blind study (Study 20120295). A total of 667 patients with a history of migraine with or without aura (≥ 15 headache days per month with ≥ 8 migraine days per month) were randomized to receive subcutaneous injection monthly for 3 months either placebo (n = 286), Aimovig 70 mg (n=191), or Aimovig 140 mg (n = 190). Randomization was stratified by region (North America vs. other) and the presence of acute medication overuse.

Patients had a median age of 43 years (range; 18 – 66 years), 83% (552/667) were female and 94% (628/667) were white. The mean migraine frequency at baseline was approximately 18 days per month. Patients were allowed to use acute headache treatments including triptans, ergotamine derivatives and nonsteroidal anti-inflammatory drugs (NSAIDs) during the study. Medication overuse was present in 41% (274/667) of patients. Overall in this study population, 68% (453/667) had failed one or more previous prophylactic treatments due to lack of efficacy or poor tolerability, and 49% (327/667) had failed two or more previous prophylactic treatments due to lack of efficacy or poor tolerability. The study excluded patients with opioid overuse and concurrent use of migraine prophylactic treatments or other headache disorders.

A total of 182 (96%) patients in the Aimovig 140 mg arm, 184 (96%) patients in the Aimovig 70 mg arm and 265 (93%) patients in the placebo arm completed the study (completed week 12 assessment). Of the 23 (3.4%) patients who discontinued treatment, two patients in the Aimovig 140 mg-treated group, no patients in the Aimovig 70 mg-treated group and two patients in the placebo group discontinued due to adverse events.

The primary outcome measure was the change in monthly migraine days from baseline to the last 4 weeks of the 12-week double-blind treatment phase. Secondary outcome measures included amongst others the achievement of 50% or more reduction in monthly migraine days from baseline ($\geq 50\%$ responders) and change from baseline in monthly acute migraine-specific medication days. Results are presented in Table 7.

Table 7 Efficacy Outcomes at Month 3 (Study 20120295)

	Aimovig 70 mg N = 188	Aimovig 140 mg N = 187	Placebo N = 281	Treatment Difference
Monthly migraine days (MMD)				
Baseline	17.94	17.78	18.24	
Week 12	11.34	11.28	14.03	
Mean change ^a (95% CI)	-6.64 (-7.47; -5.81)	-6.63 (-7.45, -5.80)	-4.18 (-4.86, -3.50)	<u>70 mg-placebo</u> : -2.46 (-3.52, -1.39) <u>140 mg-placebo</u> : -2.45 (-3.51, -1.38)
(p-value) ^b				Both < 0.001 ^b
$\geq 50\%$ MMD responders				
%	39.9%	41.2%	23.5%	
Odds ratio ^c (95% CI)				<u>70 mg-placebo</u> : 2.18 (1.46, 3.27) <u>140 mg-placebo</u> : 2.34 (1.56, 3.51)
(p-value) ^b				Both < 0.001 ^b
Monthly acute migraine-specific medication days^e				
Mean change ^a (95% CI)	-3.45 (-4.02, -2.87)	-4.13 (-4.70, -3.56)	-1.58 (-2.05, -1.11)	<u>70 mg-placebo</u> : -1.86 (-2.60, -1.13) <u>140 mg-placebo</u> : -2.55 (-3.28, -1.82)
(p-value) ^b				Both < 0.001 ^b

CI = confidence interval; MMD = monthly migraine days

^a LS mean change from baseline at month 3, treatment difference, and p-value are based on a linear mixed effects model including treatment group, baseline monthly value, stratification factors (region [North America vs. Europe] and medication overuse [presence vs absence]), scheduled visit, and the interaction of treatment group with scheduled visit, without any imputation for missing data.

^b Hierarchical gate-keeping procedures and the Hochberg method were used to maintain the 2-sided study-wise

type I error at 0.05 between the 2 erenumab doses and the primary and secondary endpoints.

^c Odds ratio and p-value for $\geq 50\%$ responders at month 3 are based on a stratified Cochran-Mantel-Haenszel test after missing data were imputed as non-response.

^d Migraine-specific medications include triptans and ergotamine derivatives.

A treatment effect was observed in a prespecified monthly analysis as early as month one.

In patients failing one or more prophylactic pharmacotherapies (68%) the treatment difference for the reduction of monthly migraine days (MMD) observed between erenumab 140 mg and placebo was -3.3 days and between erenumab 70 mg and placebo -2.5 days. In patients failing two or more prophylactic pharmacotherapies (49%) the treatment difference was -4.3 days between 140 mg and placebo and -2.7 days between 70 mg and placebo.

Approximately 41% of patients in the study had medication overuse. The treatment difference observed between erenumab 140 mg and placebo and between erenumab 70 mg and placebo for the reduction of MMD in these patients was -3.1 days in both cases.

Episodic Migraine

Aimovig was evaluated for prevention of episodic migraine in a phase 3 randomized, multi-centre, 24-week, placebo-controlled, double-blind study (Study 20120296). A total of 955 patients with history of migraine with or without aura for a duration of ≥ 12 months and 4 – 14 migraine days per month were randomized to receive subcutaneous injection monthly for 6 months either Aimovig 70 mg (n=317), Aimovig 140 mg (n = 319), or placebo (n = 319). Randomization was stratified by prior, concomitant, or no prior use of prophylactic medications and region (North America vs. other).

Patients had a median age of 42 years (range; 18 – 65 years), 85% (814/955) were female and 89% (851/955) were white. The mean migraine frequency at baseline was approximately 8 migraine days per month. Patients were allowed to use acute headache treatments including triptans, ergotamine derivatives and NSAIDs. Overall in this study population, 39% (370/955) had failed one or more previous prophylactic treatments due to lack of efficacy or poor tolerability, and 17% (161/955) had failed two or more previous prophylactic treatments due to lack of efficacy or poor tolerability. The study excluded patients with opioid overuse and other headache disorders. Only a few patients with a concomitant prophylactic medication were enrolled. A total of 292 (92%) patients in the Aimovig 140 mg arm, 284 (90%) patients in the Aimovig 70 mg arm and 282 (88%) patients in the placebo arm completed the double-blind phase. Of the 87 (9.14%) patients who discontinued treatment, 7 (2.2%) patients in the 70 mg Aimovig group, 6 (1.9%) patients in the 140 mg Aimovig group and 7 (2.2%) patients in the placebo group discontinued due to adverse events.

The primary outcome measure was the change from baseline in mean monthly migraine days. The mean monthly migraine days were calculated using the monthly migraine days from each of the last 3 months of the double-blind treatment phase. Secondary outcome measures included amongst others the achievement of a 50% or more reduction in mean monthly migraine days from baseline ($\geq 50\%$ responders) and change from baseline in mean monthly acute migraine-specific medication days.

Results are presented in Table 8.

Table 8 Efficacy Outcomes at Months 4 – 6 (Study 20120296)

	Aimovig 70 mg N = 312	Aimovig 140 mg N = 318	Placebo N = 316	Treatment Difference
Monthly migraine days (MMD)				
Baseline	8.31	8.33	8.25	
Mean of months 4-6	4.95	4.48	6.33	
Mean change ^a (95% CI)	-3.23 (-3.58, -2.88)	-3.67 (-4.02, -3.33)	-1.83 (-2.18, -1.48)	<u>70 mg-placebo</u> : -1.40 (-1.88, -0.92) <u>140 mg-placebo</u> : -1.85 (-2.33, -1.37)
(p-value) ^b				Both < 0.001 ^b
$\geq 50\%$ MMD responders				
%	43.3	50.0	26.6	
Odds ratio ^c (95% CI)				<u>70 mg-placebo</u> : 2.13 (1.52, 2.98) <u>140 mg-placebo</u> : 2.81 (2.01, 3.94)
(p-value) ^b				Both < 0.001 ^b
Monthly acute migraine-specific medication days^e				
Mean change ^a (95% CI)	-1.13 (-1.34, -0.92)	-1.61 (-1.83, -1.40)	-0.20 (-0.41, 0.02)	<u>70 mg-placebo</u> : -0.94 (-1.23, -0.64) <u>140 mg-placebo</u> : -1.42 (-1.71, -1.12)
(p-value) ^b				Both < 0.001 ^b
CI = confidence interval; MMD = Monthly Migraine Days				
^a LS mean change from baseline at month 4 – 6, treatment difference, and p-value are based on a linear mixed effects model including treatment group, baseline value, stratification factors (region [North America vs. rest of				

	Aimovig 70 mg N = 312	Aimovig 140 mg N = 318	Placebo N = 316	Treatment Difference
<p>world] and prior prophylactic medication use [naïve, prior use only, concurrent use]), scheduled visit, and the interaction of treatment group with scheduled visit, without any imputation for missing data.</p> <p>^b Hierarchical gate-keeping procedures and the Hochberg method were used to maintain the 2-sided study-wise type I error at 0.05 between the 2 erenumab doses and the primary and secondary endpoints.</p> <p>^c Odds ratio and p-value for $\geq 50\%$ responders at month 4-6 are based on a stratified Cochran-Mantel-Haenszel test after missing data were imputed as non-response.</p> <p>^d Migraine-specific medications include triptans and ergotamine derivatives.</p>				

A treatment effect was observed in a prespecified monthly analysis as early as month one.

In patients failing one or more prophylactic pharmacotherapies (39%) the treatment difference for the reduction of MMD observed between erenumab 140 mg and placebo was -2.5 and between erenumab 70 mg and placebo -2.0.

14.2 Comparative Bioavailability Studies

The results from a comparative bioavailability study (Study 20160349) investigating the bioavailability of a single subcutaneous dose of 140 mg Aimovig delivered by pre-filled syringe as one injection of erenumab 140 mg (test; 1 x 140 mg/mL; Novartis Pharmaceuticals Canada Inc.) compared to two injections of erenumab 70 mg (reference; 2 x 70 mg/mL; Novartis Pharmaceuticals Canada Inc.) in healthy volunteers are presented below. This was a Phase I, multicenter, open-label, randomized, single-dose, parallel-group study with 211 healthy adult subjects, 18 to 55 years old.

Table 9 Summary Table of the Comparative Bioavailability Data (Study 20160349)

erenumab (1 x 140 mg) From measured data Least Squares Geometric Means Arithmetic Mean (CV%)				
Parameter	Aimovig 1 x 140 mg/mL	Aimovig 2 x 70 mg/mL	% Ratio of Geometric Means	90% Confidence Interval
AUC _{inf} (day*µg/mL)	333.25 358 (35.2)	364.39 381 (28.4)	0.91 NA	(0.84, 0.99) NA
AUC _{last} (day*µg/mL)	339.43 361 (33.5)	365.43 382 (27.8)	0.93 NA	(0.86, 1.01) NA
C _{MAX} (µg/mL)	12.43 13.2 (32.5)	13.04 13.6 (26.3)	0.95 NA	(0.88, 1.03) NA

14.3 Immunogenicity

As with all therapeutic proteins, there is potential for immunogenicity. The immunogenicity of Aimovig has been evaluated using an immunoassay for the detection of binding anti-erenumab antibodies. For patients whose sera tested positive in the screening immunoassay, an *in vitro* biological assay was performed to detect neutralizing antibodies.

In the pivotal studies, the incidence of anti-erenumab antibody development among subjects was 6.3% (56/884) among subjects receiving a 70 mg dose of erenumab (3 of whom had *in vitro* neutralizing activity) and 2.6% (13/504) in patients receiving Aimovig 140 mg once monthly (none of whom had *in vitro* neutralizing activity). The mean trough levels of erenumab at week 12 were 40% lower among anti-erenumab antibody-positive subjects than among antibody-negative subjects. There was no impact of anti-erenumab antibody development on efficacy or safety of erenumab.

The incidence of anti-drug antibodies (ADAs) is highly dependent on the sensitivity and specificity of the assay. Additionally, the observed incidence of antibody (including neutralizing antibody) positivity in an assay may be influenced by several factors, including assay methodology, sample handling, timing of sample collection, concomitant medications, and underlying disease. For these reasons, comparison of the incidence of antibodies to erenumab with the incidence of antibodies to other products may be misleading.

15 MICROBIOLOGY

No microbiological information is required for this drug product.

16 NON-CLINICAL TOXICOLOGY

General Toxicology: In a repeat-dose toxicity study conducted in sexually mature cynomolgus monkeys, there were no erenumab-related adverse effects at doses up to 150 mg/kg administered subcutaneously twice weekly for up to 6 months. At the no-observed-adverse-effect level (NOAEL) of 150 mg/kg, systemic exposure was 123-fold higher than that predicted for the maximum recommended clinical dose of 140 mg once monthly based on serum AUC.

Carcinogenicity: Animal studies have not been performed to evaluate the carcinogenic potential of erenumab.

Genotoxicity: No studies have been performed to evaluate the genotoxic potential of erenumab.

Reproductive and Developmental Toxicology: No dedicated fertility studies have been conducted in animals. However, in the 6-month toxicity study conducted in sexually mature cynomolgus monkeys, there were no erenumab-related adverse histopathological changes in male and female reproductive organs at systemic exposures up to 123-fold than that predicted for the maximum recommended clinical dose of 140 mg once monthly based on serum AUC.

In an enhanced pre- and post-natal developmental study conducted in cynomolgus monkeys, there were no erenumab-related adverse effects on pregnancy or on embryo-fetal and post-natal development (up to 6 months age) when erenumab was administered at a dose of 50 mg/kg subcutaneously every two weeks from gestation day 20-22 to parturition. At the NOAEL of 50 mg/kg, maternal systemic exposure was 17-fold higher than that predicted for the maximum recommended clinical dose of 140 mg once monthly. Measurable erenumab serum concentrations, greater than those observed in maternal animals, were observed in the infant monkeys at birth, demonstrating that erenumab crosses the placental barrier.

Safety Pharmacology: In a study conducted in conscious telemetered cynomolgus monkeys administered a single subcutaneous dose of 225 mg/kg of erenumab, there were no erenumab-related adverse neurobehavioral effects or adverse effects on respiration rate and cardiovascular endpoints (e.g. arrhythmias, ECG waveform, QRS duration, and QTc interval).

PATIENT MEDICATION INFORMATION

READ THIS FOR SAFE AND EFFECTIVE USE OF YOUR MEDICINE

Pr **AIMOVIG®**

(erenumab injection)

(AIM-oh-vig)

Single-Dose Pre-filled Syringe

Read this carefully before you start taking **Aimovig®** and each time you get a refill. This leaflet is a summary and will not tell you everything about this drug. Talk to your healthcare professional about your medical condition and treatment and ask if there is any new information about **Aimovig**.

What is Aimovig used for?

- Aimovig is a medicine used to prevent migraines in adults who have at least 4 migraine days per month.

How does Aimovig work?

Aimovig works by blocking the activity of a molecule called calcitonin gene-related peptide or CGRP. CGRP has been linked to migraine.

What are the ingredients in Aimovig?

Medicinal ingredient: erenumab.

Non-medicinal ingredients: acetate, polysorbate 80, sodium hydroxide, sucrose, water for injection.

Aimovig comes in the following dosage forms:

- Solution for injection in single-dose pre-filled syringe* (70 mg/mL or 140 mg/mL).
- Solution for injection in single-dose autoinjector (SureClick®) (70 mg/mL or 140 mg/mL).

*Pre-filled syringes are not available in Canada.

Do not use Aimovig if:

You should not take Aimovig if you have ever had an allergic reaction to:

- Aimovig or any of the ingredients in Aimovig.
- Rubber or latex. The needle cap of the pre-filled syringe contains natural rubber, which is made from latex.

To help avoid side effects and ensure proper use, talk to your healthcare professional before you take Aimovig. Talk about any health conditions or problems you may have, including if you:

Tell your healthcare professional or get emergency medical help immediately:

- If you get any symptoms of a serious allergic reaction, such as rash or swelling usually of the face, mouth, tongue, or throat; or difficulty breathing. Serious allergic reactions can happen within minutes, but some may happen more than one week after using Aimovig.
- If you get severe constipation or constipation associated with symptoms such as severe or constant belly pain, vomiting, swelling of belly, hard and dry stool, tear and bleeding around the anus or bloating. Constipation with serious complications can happen after receiving Aimovig. In some cases, people have been hospitalized or needed surgery.

Children and adolescents

Do not give Aimovig to children under 18 years of age since the use of Aimovig has not been studied in children under 18 years of age.

Pregnancy and Breast-feeding

Aimovig has not been studied in pregnant women. It is not known if Aimovig will harm your unborn baby. Talk to your healthcare professional if you are trying to get pregnant or think you may be pregnant before taking Aimovig. Your healthcare professional will discuss with you the potential risks of taking Aimovig during pregnancy.

It is not known if Aimovig passes through breast milk. It is important to tell your healthcare professional if you are breastfeeding or plan to breastfeed. Your healthcare professional will then help you decide if you should stop breast-feeding, or stop taking Aimovig.

Tell your healthcare professional about all the medicines you take, including any drugs, vitamins, minerals, natural supplements or alternative medicines.

How to take Aimovig:

See the detailed “Instructions for preparing and giving an injection of Aimovig” below about the right way to prepare and give your Aimovig injections at home.

Always use Aimovig exactly as your healthcare professional has told you. Check with your healthcare professional if you are not sure.

Do not exceed the recommended dose prescribed by your healthcare professional.

Aimovig comes in a pre-filled syringe or autoinjector (SureClick). Your healthcare professional will prescribe the type that is best for you. Each pre-filled syringe or autoinjector is for a single injection.

Each syringe or each autoinjector contains 70 mg or 140 mg Aimovig. Make sure that you inject the entire contents of the syringe or the autoinjector.

Your healthcare professional will give you or your caregiver training in the right way to prepare and inject. Do not try to inject Aimovig until you or your caregiver have been shown the right way by your healthcare professional.

Before injection, let Aimovig sit at room temperature (up to 25°C) for at least 30 minutes. This

will make the injection more comfortable.

Aimovig is given as an injection under the skin (subcutaneous or SC). You or your caregiver can administer the injection into your abdomen, thigh or (only if someone else is giving you the injection) into the outer area of the upper arm.

Do not give an injection in an area of the skin that is tender, bruised, red or hard. Also do not use the same spot as used for a previous injection.

Usual dose:

The usual dose for Aimovig is 70 mg once a month. Your healthcare professional might also decide you need 140 mg once a month. Take Aimovig exactly as instructed by your healthcare professional.

Continue taking Aimovig once a month for as long as your healthcare professional tells you.

Do not stop using Aimovig, without talking to your healthcare professional first. Your symptoms may return if you stop the treatment.

70 mg/mL solution for injection

If your healthcare professional prescribed the 70 mg dose, you must get one injection (subcutaneous) in your abdomen, thigh, or upper arm.

140 mg/mL solution for injection

If your healthcare professional prescribed the 140 mg dose, you must get one injection (subcutaneous) in your abdomen, thigh, or upper arm.

Overdose:

If you think you, or a person you are caring for, have taken too much Aimovig, contact a healthcare professional, hospital emergency department, or regional poison control centre immediately, even if there are no symptoms.

Missed Dose:

If you forget to take your Aimovig dose, take it as soon as you can after the missed dose. Then, contact your healthcare professional who will tell you when you should schedule your next doses, and follow that schedule exactly as your healthcare professional has told you.

What are possible side effects from using Aimovig?

As with all medicines, patients treated with Aimovig may experience side effects, although not everybody gets them.

Possible side effects include the following listed below. Most of these side effects are mild to moderate. If these side effects become severe, please tell your healthcare professional.

- Signs and symptoms of pain, redness, swelling at the injection site (injection site reactions)
- Constipation

- Muscle spasm
- Itching
- Allergic reactions such as rash or swelling or sometimes, difficulty breathing. This can happen within hours to days after using Aimovig. Call your healthcare professional or get emergency medical help right away if you have a severe allergic reaction.
- Hair loss
- Mouth/lip sores

These are not all the possible side effects you may feel when taking Aimovig. If you experience any side effects not listed here, contact your healthcare professional.

If you have a troublesome symptom or side effect that is not listed here or becomes bad enough to interfere with your daily activities, talk to your healthcare professional.

Reporting Side Effects

You can report any suspected side effects associated with the use of health products to Health Canada by:

- Visiting the Web page on Adverse Reaction Reporting (<https://www.canada.ca/en/health-canada/services/drugs-health-products/medeffect-canada.html>) for information on how to report online, by mail or by fax; or
- Calling toll-free at 1-866-234-2345.

NOTE: Contact your healthcare professional if you need information about how to manage your side effects. The Canada Vigilance Program does not provide medical advice.

Storage:

Do not use this medicine after the expiry date, which is stated on the carton.

Store in a refrigerator at 2°C to 8°C, in the original carton.

After Aimovig is removed from the refrigerator, it should be kept at controlled room temperature (up to 25°C) in the original carton and must be used within 7 days. Do not put Aimovig back in the refrigerator once they have reached room temperature.

Protect from light. Do not freeze. Do not shake.

Keep out of reach and sight of children.

If you want more information about Aimovig:

- Talk to your healthcare professional
- Find the full product monograph that is prepared for healthcare professionals and includes

this Patient Medication Information by visiting the Health Canada website:
(<https://www.canada.ca/en/health-canada/services/drugs-health-products/drug-products/drug-product-database.html>); the manufacturer's website www.novartis.ca, or by calling 1-800-363-8883.

This leaflet was prepared by Novartis Pharmaceuticals Canada Inc.

Last Revised: October 27, 2022

Novartis Version: April 04, 2023

® AIMOVIG & SureClick are registered trademarks of Amgen Inc. used under license by Novartis Pharmaceuticals Canada Inc.

Instructions for Preparing and Giving an Injection of Aimovig:

Aimovig Single-Dose Pre-filled Syringe: 70 mg/mL and 140 mg/mL

Guide to parts

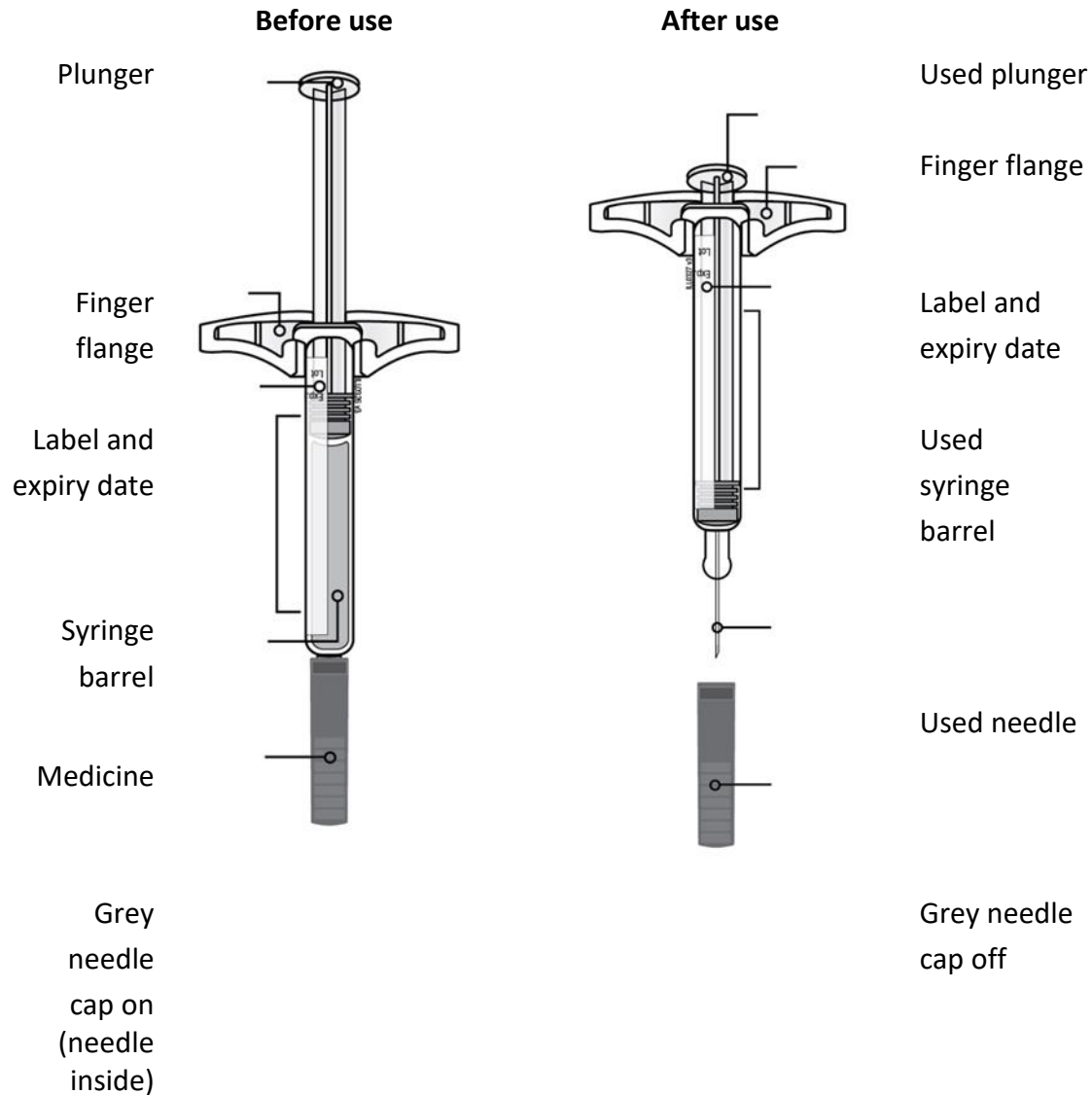

Important: Needle is inside the grey needle cap.

Important

Before you use an Aimovig pre-filled syringe, read this important information:

Storing your Aimovig pre-filled syringe

- Keep the syringe out of the sight and reach of children.
- Keep the syringe in the original carton to protect from light or physical damage.
- The syringe should be kept in the refrigerator at 2°C to 8°C.
- Throw away Aimovig that has been left at room temperature (up to 25°C) for more than

- 7 days.
- **Do not** store the syringe in extreme heat or cold. For example, avoid storing in your car.
 - **Do not** freeze.

Using your Aimovig pre-filled syringe

- **Do not** try to inject Aimovig before receiving training from your healthcare professional.
- **Do not** use a syringe after the expiry date stated on the label.
- **Do not** shake the syringe.
- **Do not** remove the grey needle cap from the syringe until you are ready to inject.
- **Do not** freeze or use the syringe if it has been frozen.
- **Do not** use a syringe if it has been dropped on a hard surface. Part of the syringe may be broken even if you cannot see the break. Use a new syringe, and contact your healthcare professional.

This product contains natural rubber latex within the grey needle cap. The product may cause allergic responses in individuals who are sensitized to latex. Tell your healthcare professional if you are allergic to latex.

For more information or help contact your healthcare professional.

Step 1: Prepare

Read this before you inject.

Check your prescription.

Your healthcare professional has prescribed a 70 mg or 140 mg dose.

For a 70 mg dose, inject one syringe of 70 mg/mL.

For a 140 mg dose, inject one syringe of 140 mg/mL if you were prescribed the 140 mg/mL formulation.

To avoid discomfort at the site of injection, leave the syringes at room temperature for at least 30 minutes before injecting.

A) Remove the Aimovig pre-filled syringe from the carton.

Grab the syringe barrel to remove the syringe from the tray.

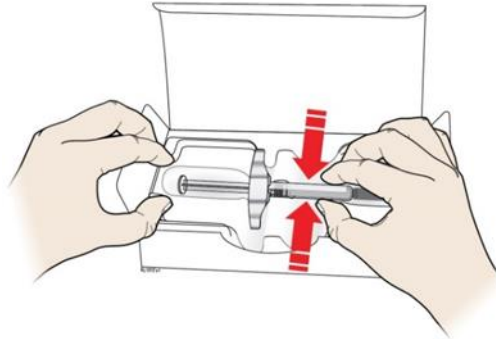
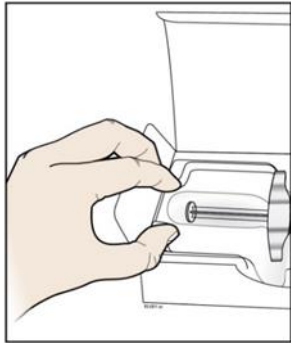

Place finger or thumb on edge of the tray to secure it while you remove the syringe.

Hold the syringe at the barrel (see arrows).

For safety reasons:

- **Do not** grab the plunger rod.
- **Do not** grab the grey needle cap.
- **Do not** remove the grey needle cap until you are ready to inject.
- **Do not** remove the finger flange. This is part of the syringe.

Leave the syringe at room temperature for at least **30** minutes before injecting.

- **Do not** put the syringe back in the refrigerator once they have reached room temperature.
- **Do not** try to warm the syringe by using a heat source such as hot water or microwave.
- **Do not** leave the syringe in direct sunlight.
- **Do not** shake the syringe.

B) Inspect the Aimovig pre-filled syringe.

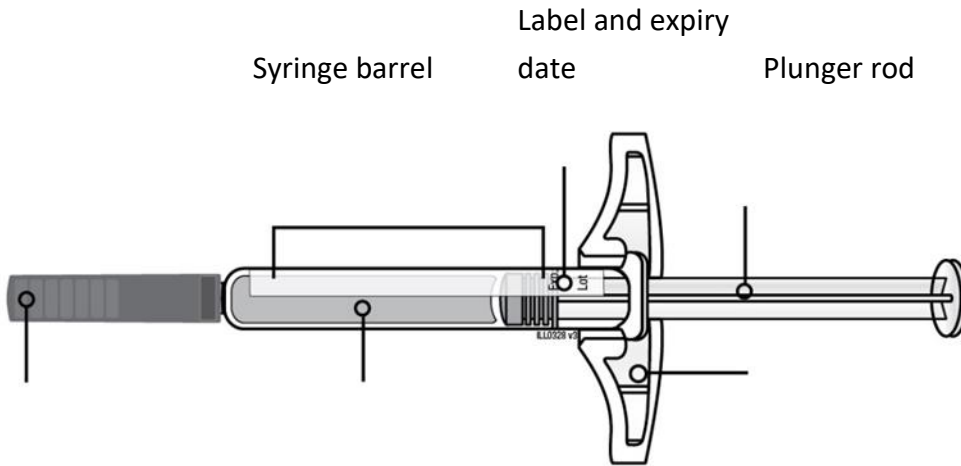

Grey needle cap on (needle inside)

Medicine

Finger flange

Always hold the syringe by the syringe barrel.

Make sure the medicine in the syringe is clear and colourless to slightly yellow.

- **Do not** use the syringe if the medicine is cloudy or discoloured or contains flakes or particles.
- **Do not** use the syringe if any part appears cracked or broken.
- **Do not** use the syringe if the syringe has been dropped.
- **Do not** use the syringe if the grey needle cap is missing or not securely attached.
- **Do not** use the syringe if the expiry date printed on the label has passed.

In all cases, use a new syringe, and in case of doubts contact your healthcare professional.

C) Gather all materials needed for the injections.

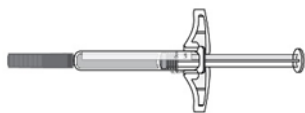

Wash your hands thoroughly with soap and water.

On a clean, well-lit work surface, place the:

- One new syringe
- Alcohol wipe
- Cotton ball(s) or gauze pad
- Adhesive bandage
- Sharps disposal container



D) Prepare and clean your injection site(s).

Only use these injection sites:

- The thigh
- Stomach area (abdomen), except for a **five** centimeter area right around the navel
- Outer area of upper arm (only if someone else is giving you the injection)

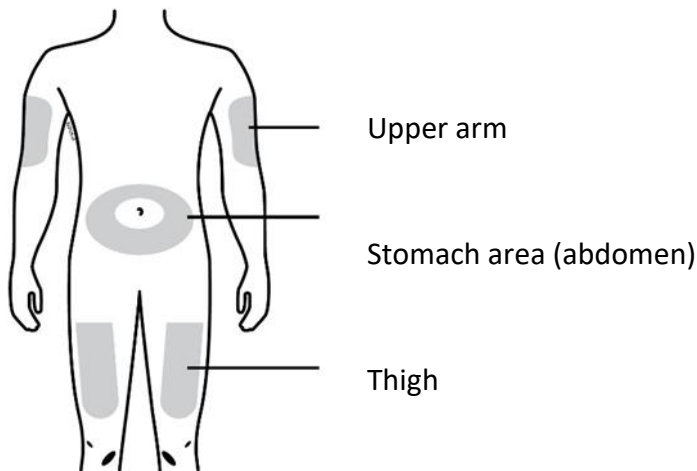

Clean your injection site with an alcohol wipe. Let your skin dry.

- **Do not** touch this area again before injecting.
- Choose a different site each time you give yourself an injection. If you need to use the same injection site, make sure it is not the same spot on the injection site that you used for a previous injection.
- **Do not** inject into areas where the skin is tender, bruised, red, or hard. Avoid injecting directly into a raised, thick, red, or scaly skin patch or lesion, or areas with scars or stretch marks.

Step 2: Get ready

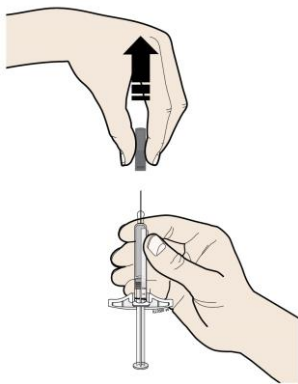

E) Pull the grey needle cap straight out and away from your body, only when you are ready to inject. **Do not** leave the grey needle cap off for more than five minutes. This can dry out the medicine.

It is normal to see a drop of liquid at the end of the needle.

- **Do not** twist or bend the grey needle cap.
- **Do not** put the grey needle cap back onto the syringe.
- **Do not** remove the grey needle cap from the syringe until you are ready to inject.

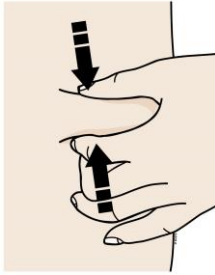

F) Pinch your injection site to create a firm surface.

Pinch skin firmly between your thumb and fingers, creating an area about **five** centimeters wide.

Important: Keep skin pinched while injecting.

Step 3: Inject



G) While pinching, with the grey needle cap off, insert the syringe into your skin at an angle of 45 to 90 degrees.

Do not place your finger on the plunger rod while inserting the needle.

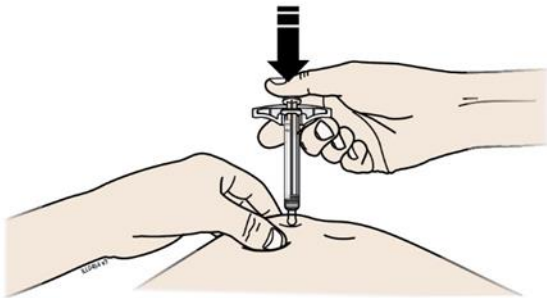

H) Using slow and constant pressure, push the plunger rod all the way down until it stops moving.

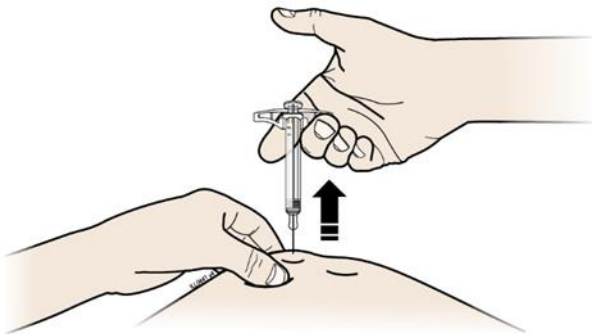

I) When done, release your thumb, and gently lift the syringe off of the skin

Important: When you remove the syringe, if it looks like the medicine is still in the syringe barrel, this means you have not received a full dose. Call your healthcare professional immediately.

Step 4: Finish



J) Discard the used syringe and the grey needle cap.

Put the used Aimovig syringe in a sharps disposal container right away after use. **Do not** throw away (dispose of) the syringe in your household trash.

- **Do not** reuse the syringe.
- **Do not** recycle the syringe or sharps disposal container or throw them into household trash.

Important: Always keep the sharps disposal container out of the sight and reach of children.

If you do not have a sharps disposal container, you may use a household container that is:

- Made of a heavy-duty plastic.
- Can be closed with a tight-fitting, puncture-resistant lid, without sharps being able to come out.
- Upright and stable during use.
- Leak-resistant.
- Properly labeled to warn of hazardous waste inside the container.

When your sharps disposal container is almost full, you will need to follow your community guidelines for the right way to dispose of your sharps disposal container. There may be provincial or local laws about how you should throw away used needles and syringes.

K) Examine the injection site.

If there is blood, press a cotton ball or gauze pad on your injection site. **Do not** rub the injection site. Apply an adhesive bandage if needed.

PATIENT MEDICATION INFORMATION

READ THIS FOR SAFE AND EFFECTIVE USE OF YOUR MEDICINE

Pr **AIMOVIG**[®]

(erenumab injection)

(AIM-oh-vig)

Single-Dose Pre-filled SureClick[®] Autoinjector

Read this carefully before you start taking **Aimovig**[®] and each time you get a refill. This leaflet is a summary and will not tell you everything about this drug. Talk to your healthcare professional about your medical condition and treatment and ask if there is any new information about **Aimovig**.

What is Aimovig used for?

- Aimovig is a medicine used to prevent migraines in adults who have at least 4 migraine days per month.

How does Aimovig work?

Aimovig works by blocking the activity of a molecule called calcitonin gene-related peptide or CGRP. CGRP has been linked to migraine.

What are the ingredients in Aimovig?

Medicinal ingredient: erenumab.

Non-medicinal ingredients: acetate, polysorbate 80, sodium hydroxide, sucrose, water for injection.

Aimovig comes in the following dosage forms:

- Solution for injection in single-dose pre-filled syringe* (70 mg/mL or 140 mg/mL).
- Solution for injection in single-dose autoinjector (SureClick[®]) (70 mg/mL or 140 mg/mL).

*Pre-filled syringes are not available in Canada.

Do not use Aimovig if:

You should not take Aimovig if you have ever had an allergic reaction to:

- Aimovig or any of the ingredients in Aimovig.
- Rubber or latex. The white or orange cap on the autoinjector contains a needle cover that is composed of natural rubber, which is made from latex.

To help avoid side effects and ensure proper use, talk to your healthcare professional before you take Aimovig. Talk about any health conditions or problems you may have, including if you:

Tell your healthcare professional or get emergency medical help immediately:

- If you get any symptoms of a serious allergic reaction, such as rash or swelling usually of the face, mouth, tongue, or throat; or difficulty breathing. Serious allergic reactions can happen within minutes, but some may happen more than one week after using Aimovig.
- If you get severe constipation or constipation associated with symptoms such as severe or constant belly pain, vomiting, swelling of belly, hard and dry stool, tear and bleeding around the anus or bloating. Constipation with serious complications can happen after receiving Aimovig. In some cases, people have been hospitalized or needed surgery.

Children and adolescents

Do not give Aimovig to children under 18 years of age since the use of Aimovig has not been studied in children under 18 years of age.

Pregnancy and Breast-feeding

Aimovig has not been studied in pregnant women. It is not known if Aimovig will harm your unborn baby. Talk to your healthcare professional if you are trying to get pregnant or think you may be pregnant before taking Aimovig. Your healthcare professional will discuss with you the potential risks of taking Aimovig during pregnancy.

It is not known if Aimovig passes through breast milk. It is important to tell your healthcare professional if you are breastfeeding or plan to breastfeed. Your healthcare professional will then help you decide if you should stop breast-feeding, or stop taking Aimovig.

Tell your healthcare professional about all the medicines you take, including any drugs, vitamins, minerals, natural supplements or alternative medicines.

How to take Aimovig:

See the detailed “Instructions for preparing and giving an injection of Aimovig” below about the right way to prepare and give your Aimovig injections at home.

Always use Aimovig exactly as your healthcare professional has told you. Check with your healthcare professional if you are not sure.

Do not exceed the recommended dose prescribed by your healthcare professional.

Aimovig comes in a pre-filled syringe or autoinjector (SureClick). Your healthcare professional will prescribe the type that is best for you. Each pre-filled syringe or autoinjector is for a single injection.

Each syringe or each autoinjector contains 70 mg or 140 mg Aimovig. Make sure that you inject the entire contents of the syringe or the autoinjector.

Your healthcare professional will give you or your caregiver training in the right way to prepare and inject. Do not try to inject Aimovig until you or your caregiver have been shown the right way by your healthcare professional.

Before injection, let Aimovig sit at room temperature (up to 25°C) for at least 30 minutes. This will make the injection more comfortable.

Aimovig is given as an injection under the skin (subcutaneous or SC). You or your caregiver can administer the injection into your abdomen, thigh or (only if someone else is giving you the injection) into the outer area of the upper arm.

Do not give an injection in an area of the skin that is tender, bruised, red or hard. Also do not use the same spot as used for a previous injection.

Usual dose:

The usual dose for Aimovig is 70 mg once a month. Your healthcare professional might also decide you need 140 mg once a month. Take Aimovig exactly as instructed by your healthcare professional.

Continue taking Aimovig once a month for as long as your healthcare professional tells you.

Do not stop using Aimovig, without talking to your healthcare professional first. Your symptoms may return if you stop the treatment.

70 mg/mL solution for injection

If your healthcare professional prescribed the 70 mg dose, you must get one injection (subcutaneous) in your abdomen, thigh, or upper arm.

140 mg/mL solution for injection

If your healthcare professional prescribed the 140 mg dose, you must get one injection (subcutaneous) in your abdomen, thigh, or upper arm.

Overdose:

If you think you, or a person you are caring for, have taken too much Aimovig, contact a healthcare professional, hospital emergency department, or regional poison control centre immediately, even if there are no symptoms.

Missed Dose:

If you forget to take your Aimovig dose, take it as soon as you can after the missed dose. Then, contact your healthcare professional who will tell you when you should schedule your next doses, and follow that schedule exactly as your healthcare professional has told you.

What are possible side effects from using Aimovig?

As with all medicines, patients treated with Aimovig may experience side effects, although not everybody gets them.

Possible side effects include the following listed below. Most of these side effects are mild to moderate. If these side effects become severe, please tell your healthcare professional.

- Signs and symptoms of pain, redness, swelling at the injection site (injection site reactions)
- Constipation
- Muscle spasm

- Itching
- Allergic reactions such as rash or swelling or sometimes, difficulty breathing. This can happen within hours to days after using Aimovig. Call your healthcare professional or get emergency medical help right away if you have a severe allergic reaction.
- Hair loss
- Mouth/lip sores

These are not all the possible side effects you may feel when taking Aimovig. If you experience any side effects not listed here, contact your healthcare professional.

If you have a troublesome symptom or side effect that is not listed here or becomes bad enough to interfere with your daily activities, talk to your healthcare professional.

Reporting Side Effects

You can report any suspected side effects associated with the use of health products to Health Canada by:

- Visiting the Web page on Adverse Reaction Reporting (<https://www.canada.ca/en/health-canada/services/drugs-health-products/medeffect-canada.html>) for information on how to report online, by mail or by fax; or
- Calling toll-free at 1-866-234-2345.

NOTE: Contact your healthcare professional if you need information about how to manage your side effects. The Canada Vigilance Program does not provide medical advice.

Storage:

Do not use this medicine after the expiry date, which is stated on the carton.

Store in a refrigerator at 2°C to 8°C, in the original carton.

After Aimovig is removed from the refrigerator, it should be kept at controlled room temperature (up to 25°C) in the original carton and must be used within 7 days. Do not put Aimovig back in the refrigerator once they have reached room temperature.

Protect from light. Do not freeze. Do not shake.

Keep out of reach and sight of children.

If you want more information about Aimovig:

- Talk to your healthcare professional
- Find the full product monograph that is prepared for healthcare professionals and includes this Patient Medication Information by visiting the Health Canada website: (<https://www.canada.ca/en/health-canada/services/drugs-health-products/drug->

[products/drug-product-database.html](https://www.novartis.ca/products/drug-product-database.html); the manufacturer's website www.novartis.ca, or by calling 1-800-363-8883.

This leaflet was prepared by Novartis Pharmaceuticals Canada Inc.

Last Revised: October 27, 2022

Novartis Version: April 04, 2023

® AIMOVIG & SureClick are registered trademarks of Amgen Inc. used under license by Novartis Pharmaceuticals Canada Inc.

Instructions for preparing and giving an injection of Aimovig 70 mg/mL:

Aimovig Single-Dose Pre-filled SureClick Autoinjector 70 mg/mL:

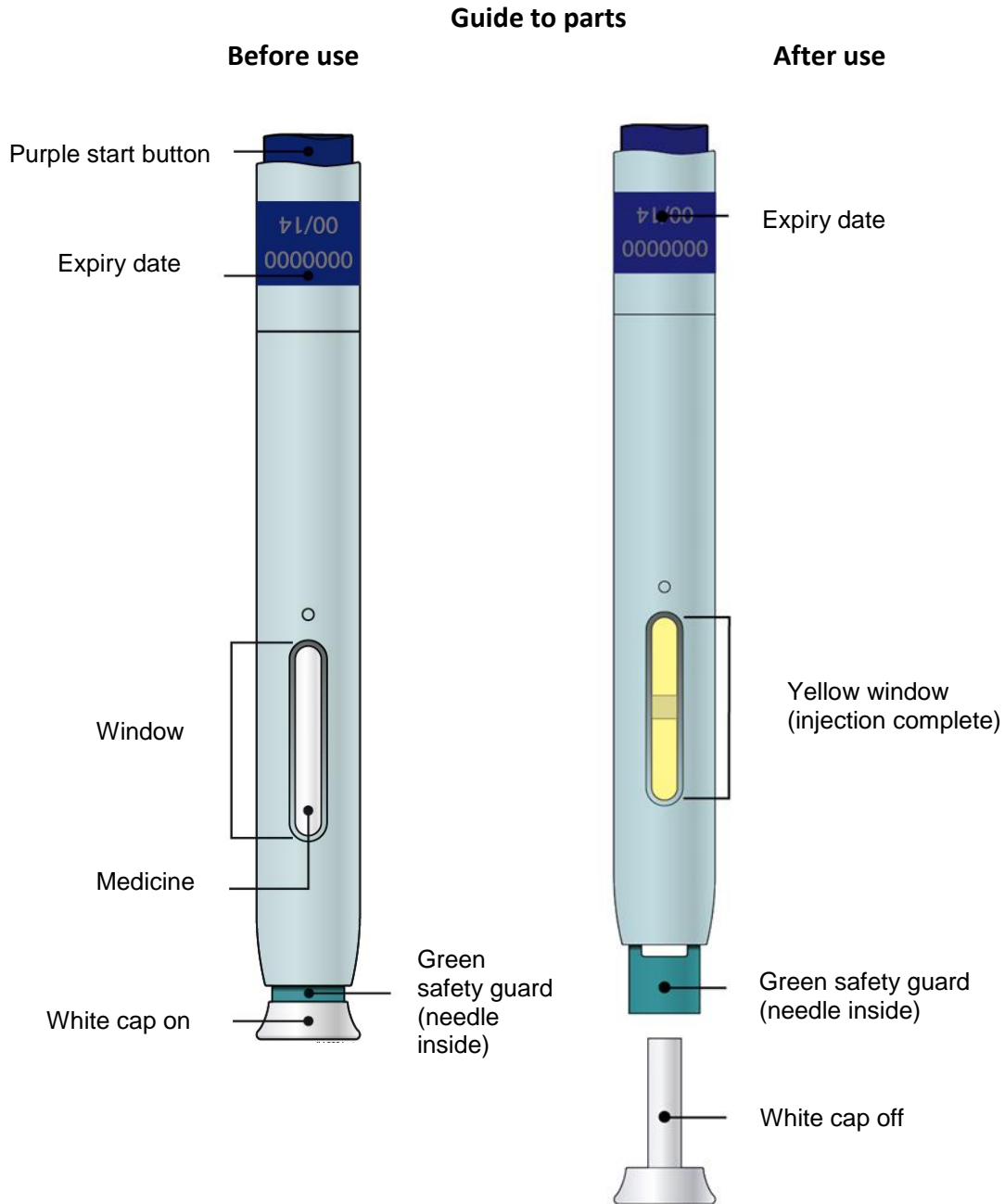

Important: Needle is inside the green safety guard.

Important

Before you use an Aimovig SureClick autoinjector, read this important information:

Storing your Aimovig SureClick autoinjector

- Keep the autoinjector out of the sight and reach of children.
- Keep the autoinjector in the original carton to protect from light or physical damage.
- The autoinjector should be kept in the refrigerator at 2°C to 8°C.
- Throw away Aimovig that has been left at room temperature (up to 25°C) for more than 7 days.
- **Do not** store the autoinjector in extreme heat or cold. For example, avoid storing in your car.
- **Do not** freeze.

Using your Aimovig SureClick autoinjector

- **Do not** try to inject Aimovig before receiving training from your healthcare professional.
- **Do not** use the autoinjector after the expiry date stated on the label.
- **Do not** shake the autoinjector.
- **Do not** remove the white cap from the autoinjector until you are ready to inject.
- **Do not** freeze or use the autoinjector if it has been frozen.
- **Do not** use the autoinjector if it has been dropped on a hard surface. Part of the autoinjector may be broken even if you cannot see the break. Use a new autoinjector, and call your healthcare professional.

This product contains natural rubber latex within the white cap. The product may cause allergic responses in individuals who are sensitized to latex. Tell your healthcare professional if you are allergic to latex.

For more information or help contact your healthcare professional.

Step 1: Prepare

Read this before you inject.

Check your prescription.

Your healthcare professional has prescribed a 70 mg.

For a 70 mg dose, inject one autoinjector of 70 mg/mL.

To avoid discomfort at the site of injection, leave the autoinjector at room temperature for at least 30 minutes before injecting.

A) Remove the Aimovig autoinjector from the carton.

Carefully lift the autoinjector straight up out of the carton.

Leave the autoinjector at room temperature for at least **30** minutes before injecting.

- **Do not** put the autoinjector back in the refrigerator once they have reached room temperature.
- **Do not** try to warm the autoinjector by using a heat source such as hot water or microwave.
- **Do not** leave the autoinjector in direct sunlight.
- **Do not** shake the autoinjector.
- **Do not** remove the white cap from the autoinjector yet.

B) Inspect the autoinjector.

Green safety guard (needle inside)

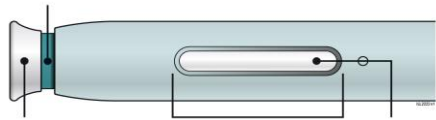

White cap on Window Medicine

Make sure the medicine in the window is clear and colorless to slightly yellow.

- **Do not** use the autoinjector if the medicine is cloudy or discolored or contains flakes or particles.
- **Do not** use the autoinjector if any part appears cracked or broken.
- **Do not** use the autoinjector if the autoinjector has been dropped.
- **Do not** use the autoinjector if the white cap is missing or not securely attached.
- **Do not** use the autoinjector if the expiry date printed on the label has passed.

In all cases, use a new autoinjector, and in case of doubts contact your healthcare professional.

C) Gather all materials needed for your injection.



Wash your hands thoroughly with soap and water.

On a clean, well-lit work surface, place the:



- Alcohol wipe
- One autoinjector
- Sharps disposal container
- Cotton ball(s) or gauze pad
- Adhesive bandage

D) Prepare and clean your injection site.

Only use these injection sites:

- The thigh
- Stomach area (abdomen), except for a **five** centimeter area right around your navel
- Outer area of upper arm (only if someone else is giving you the injection)

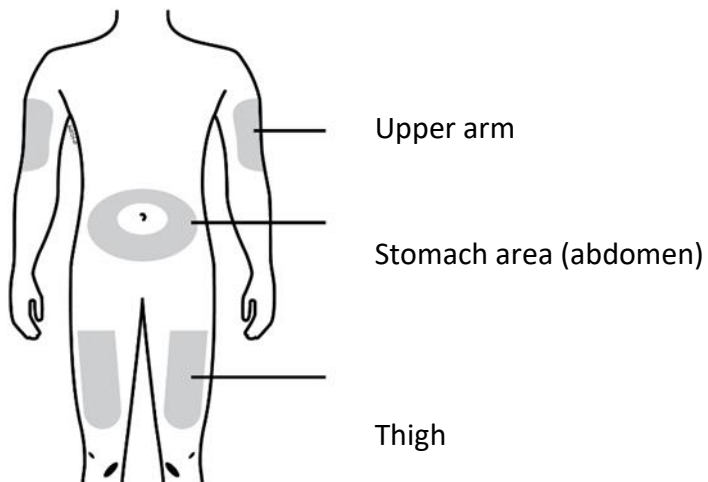

Clean your injection site with an alcohol wipe. Let your skin dry.

- **Do not** touch this area again before injecting.
- Choose a different site each time you give yourself an injection. If you need to use the same injection site, make sure it is not the same spot on the injection site that you used for a previous injection.
- **Do not** inject into areas where the skin is tender, bruised, red, or hard.
- Avoid injecting directly into a raised, thick, red, or scaly skin patch or lesion, or areas with scars or stretch marks.

Step 2: Get ready

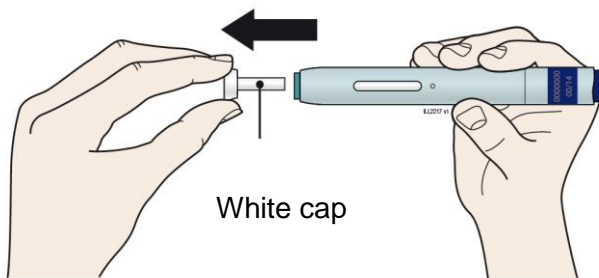

E) Pull the white cap straight off, only when you are ready to inject. **Do not** leave the white cap off for more than five minutes. This can dry out the medicine.

It is normal to see a drop of liquid at the end of the needle or green safety guard.

- **Do not** twist or bend the white cap.
- **Do not** put the white cap back onto the autoinjector.
- **Do not** put your fingers into the green safety guard.
- **Do not** remove the white cap from the autoinjector until you are ready to inject.

F) Create a firm surface at the selected injection site (thigh, stomach, or outer areas of the upper arm), by using **either** the Stretch method **or** the Pinch method.

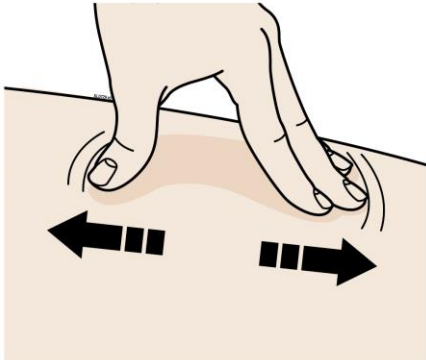

Stretch method

Stretch the skin firmly by moving your thumb and fingers in opposite directions, creating an area about **five** centimeters wide.

OR

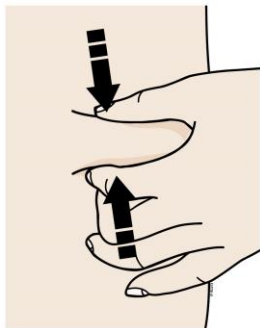

Pinch method

Pinch the skin firmly between your thumb and fingers, creating an area about **five** centimeters wide.

Important: Keep skin stretched or pinched while injecting.

Step 3: Inject

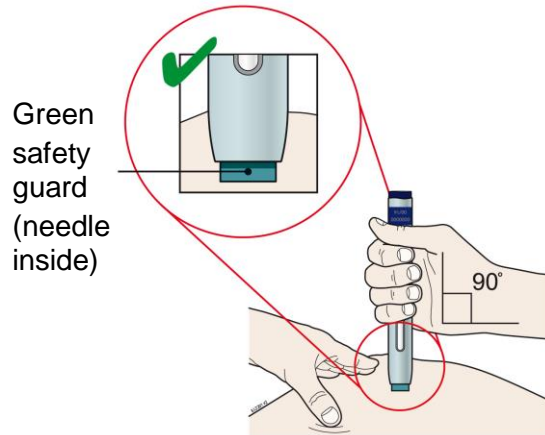

G) Keep holding the stretched or pinched skin. With the white cap off, **put** the green safety guard on the skin at an angle of 90 degrees. The needle is inside the green safety guard. Do not touch the purple start button yet.

Push down

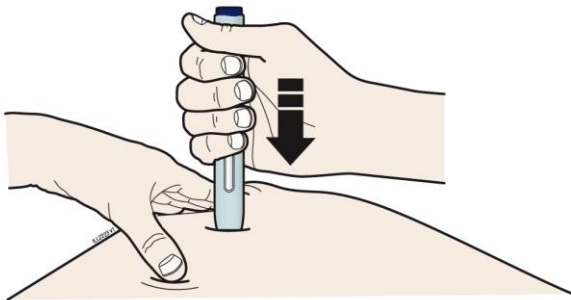

H) Firmly **push** the autoinjector down onto skin until it stops moving.

Important: You must push all the way down but do not touch the purple start button until you are ready to inject.

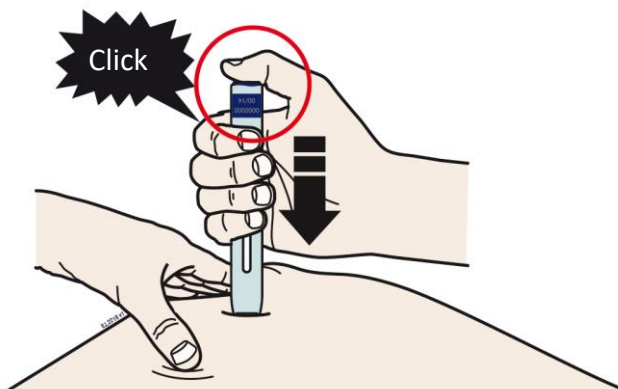

I) When you are ready to inject, **press** the purple start button.

You will hear a click.

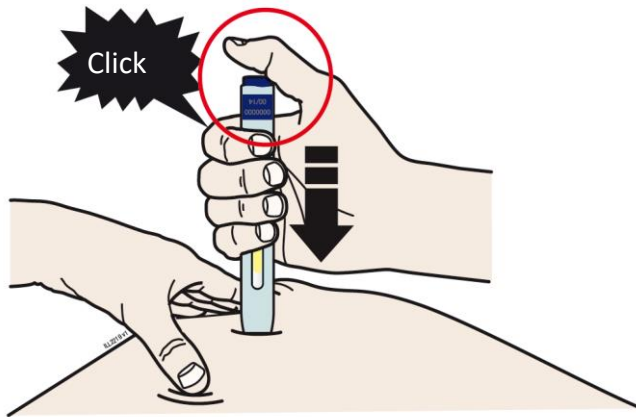

J) Remove your thumb from the button, but keep **pushing** down on the skin. Your injection could take about 15 seconds.

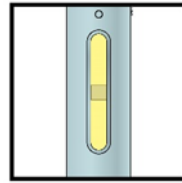

Important: Window turns from clear to yellow when injection is done and you may hear a second click.

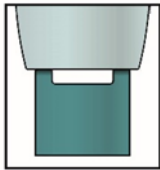

Note: After you remove the autoinjector from your skin, the needle will be automatically covered.

Important: When you remove the autoinjector, if the window has not turned yellow, or if it looks like the medicine is still being released, this means you have not received a full dose. Call your healthcare professional immediately.

Step 4: Finish



K) Discard the used autoinjector and the white cap.

Put the used SureClick autoinjector in a sharps disposal container right away after use. **Do not** throw away (dispose of) the SureClick autoinjector in your household trash.

- **Do not** reuse the autoinjector.
- **Do not** recycle the autoinjector or sharps disposal container or throw them into household trash.

Important: Always keep the sharps disposal container out of the sight and reach of children.

If you do not have a sharps disposal container, you may use a household container that is:

- Made of a heavy-duty plastic.
- Can be closed with a tight-fitting, puncture-resistant lid, without sharps being able to

come out.

- Upright and stable during use.
- Leak-resistant.
- Properly labeled to warn of hazardous waste inside the container.

When your sharps disposal container is almost full, you will need to follow your community guidelines for the right way to dispose of your sharps disposal container. There may be provincial or local laws about how you should throw away used needles and syringes.

L) Examine the injection site.

If there is blood, press a cotton ball or gauze pad on your injection site. **Do not** rub the injection site. Apply an adhesive bandage if needed.

Commonly asked questions

What will happen if I press the purple start button before I am ready to do the injection on my skin?

Even when you press the purple start button, the injection will only happen when the green safety guard is also pushed into the autoinjector.

Can I move the autoinjector around on my skin while I am choosing an injection site?

It is okay to move the autoinjector around on the injection site as long as you **do not** press the purple start button. However, if you press the purple start button and the green safety guard is pushed into the autoinjector, the injection will begin.

Can I release the purple start button after I start my injection?

You can release the purple start button, but continue to hold the autoinjector firmly against your skin during the injection.

Will the purple start button pop up after I release my thumb?

The purple start button may not pop up after you release your thumb if you held your thumb down during the injection. This is okay.

What do I do if I didn't hear a click after pushing the device down on my skin for 15 seconds?

If you didn't hear a click, you can confirm a complete injection by checking that the window has turned yellow.

Whom do I contact if I need help with the autoinjector or my injection?

If you have any questions about the autoinjector, its storage, or about your injection contact your healthcare professional.

Instructions for preparing and giving an injection of Aimovig 140 mg/mL:

Aimovig Single-Dose Pre-filled SureClick Autoinjector 140 mg/mL:

Guide to parts

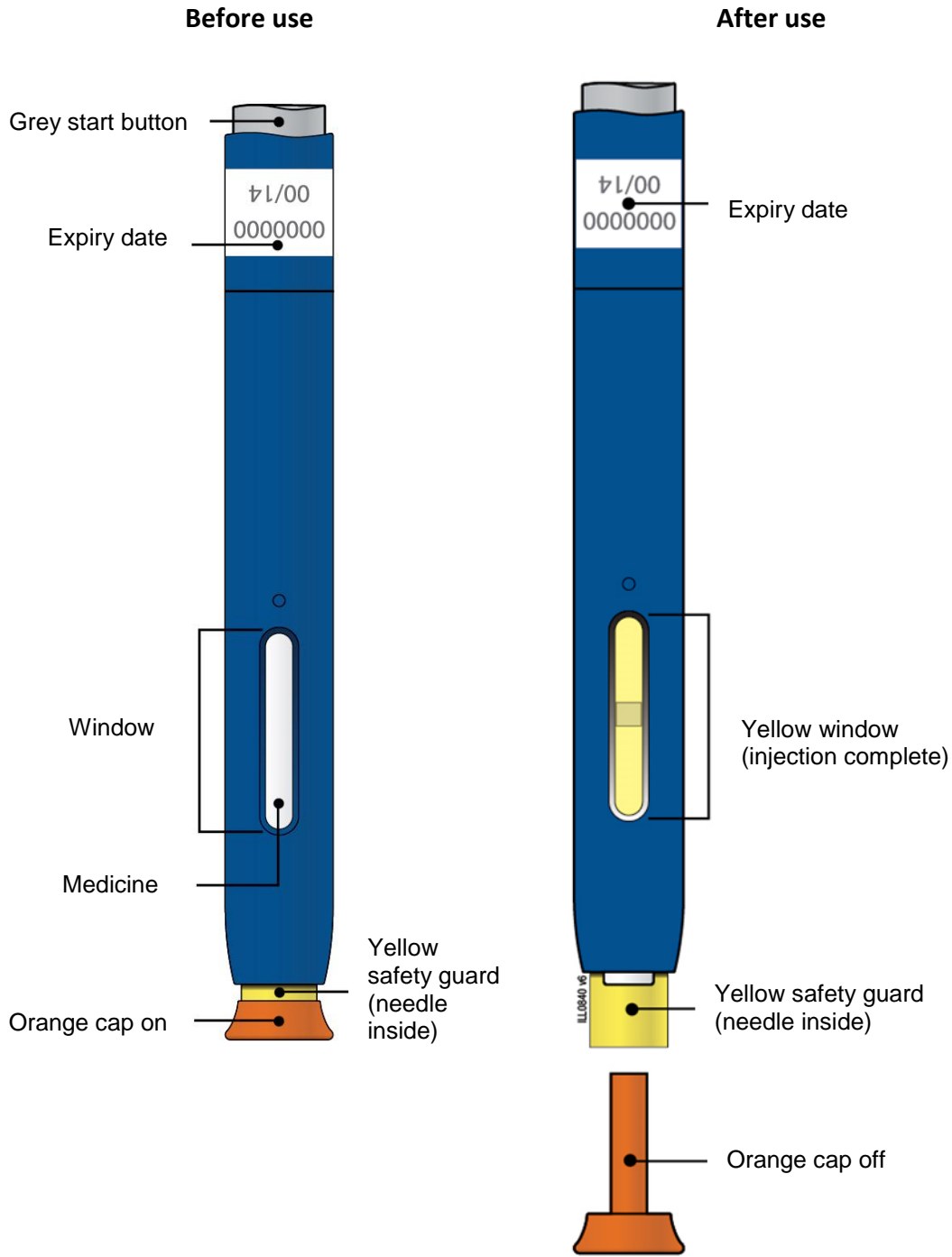

Important: Needle is inside the yellow safety guard.

Important

Before you use an Aimovig SureClick autoinjector, read this important information:

Storing your Aimovig SureClick autoinjector

- Keep the autoinjector out of the sight and reach of children.
- Keep the autoinjector in the original carton to protect from light or physical damage.
- The autoinjector should be kept in the refrigerator at 2°C to 8°C.
- Throw away Aimovig that has been left at room temperature (up to 25°C) for more than 7 days.
- **Do not** store the autoinjector in extreme heat or cold. For example, avoid storing in your car.
- **Do not** freeze.

Using your Aimovig SureClick autoinjector

- **Do not** try to inject Aimovig before receiving training from your healthcare professional.
- **Do not** use the autoinjector after the expiry date stated on the label.
- **Do not** shake the autoinjector.
- **Do not** remove the orange cap from the autoinjector until you are ready to inject.
- **Do not** freeze or use the autoinjector if it has been frozen.
- **Do not** use the autoinjector if it has been dropped on a hard surface. Part of the autoinjector may be broken even if you cannot see the break. Use a new autoinjector, and call your healthcare professional.

This product contains natural rubber latex within the orange cap. The product may cause allergic responses in individuals who are sensitized to latex. Tell your healthcare professional if you are allergic to latex.

For more information or help contact your healthcare professional.

Step 1: Prepare

Read this before you inject.

Check your prescription.

Your healthcare professional has prescribed a 140 mg dose.

For a 140 mg dose, inject one autoinjector of 140 mg/mL.

To avoid discomfort at the site of injection, leave the autoinjector at room temperature for at least 30 minutes before injecting.

A) Remove the Aimovig autoinjector from the carton.

Carefully lift the autoinjector straight up out of the carton.

Leave the autoinjector at room temperature for at least **30** minutes before injecting.

- **Do not** put the autoinjector back in the refrigerator once they have reached room temperature.
- **Do not** try to warm the autoinjector by using a heat source such as hot water or microwave.
- **Do not** leave the autoinjector in direct sunlight.
- **Do not** shake the autoinjector.
- **Do not** remove the orange cap from the autoinjector yet.

B) Inspect the autoinjector.

Yellow safety guard (needle inside)



Orange cap on Window Medicine

Make sure the medicine in the window is clear and colorless to slightly yellow.

- **Do not** use the autoinjector if the medicine is cloudy or discolored or contains flakes or particles.
- **Do not** use the autoinjector if any part appears cracked or broken.
- **Do not** use the autoinjector if the autoinjector has been dropped.
- **Do not** use the autoinjector if the orange cap is missing or not securely attached.
- **Do not** use the autoinjector if the expiry date printed on the label has passed.

In all cases, use a new autoinjector, and in case of doubts contact your healthcare professional.

C) Gather all materials needed for your injection.



Wash your hands thoroughly with soap and water.

On a clean, well-lit work surface, place the:

- Alcohol wipe
- One new autoinjector
- Sharps disposal container
- Cotton ball(s) or gauze pad(s)
- Adhesive bandage

D) Prepare and clean your injection site.

Only use these injection sites:

- The thigh
- Stomach area (abdomen), except for a **five** centimeter area right around your navel
- Outer area of upper arm (only if someone else is giving you the injection)

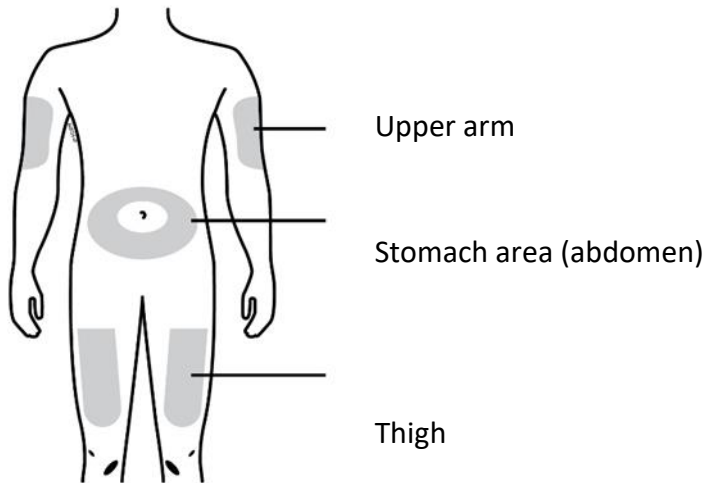

Clean your injection site with an alcohol wipe. Let your skin dry.

- **Do not** touch this area again before injecting.
- Choose a different site each time you give yourself an injection. If you need to use the same injection site, make sure it is not the same spot on the injection site that you used for a previous injection.
- **Do not** inject into areas where the skin is tender, bruised, red, or hard.
- Avoid injecting directly into a raised, thick, red, or scaly skin patch or lesion, or areas with scars or stretch marks.

Step 2: Get ready

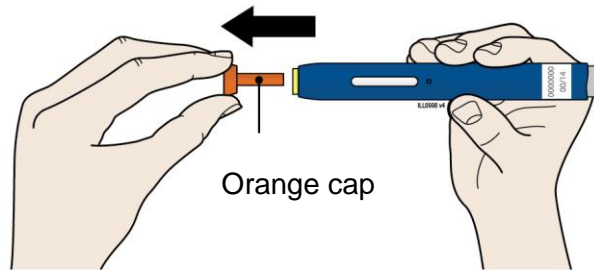

E) Pull the orange cap straight off, only when you are ready to inject. **Do not** leave the orange cap off for more than five minutes. This can dry out the medicine.

It is normal to see a drop of liquid at the end of the needle or yellow safety guard.

- **Do not** twist or bend the orange cap.
- **Do not** put the orange cap back onto the autoinjector.
- **Do not** put your fingers into the yellow safety guard.
- **Do not** remove the orange cap from the autoinjector until you are ready to inject.

F) Create a firm surface at the selected injection site (thigh, stomach, or outer areas of the upper arm), by using **either** the Stretch method **or** the Pinch method.

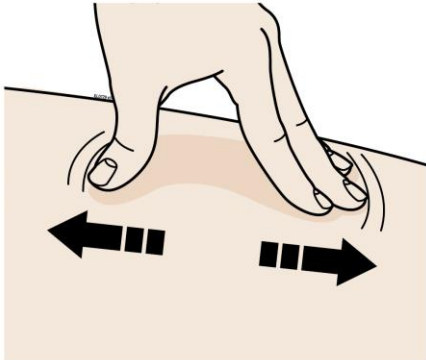

Stretch method

Stretch the skin firmly by moving your thumb and fingers in opposite directions, creating an area about **five** centimeters wide.

OR

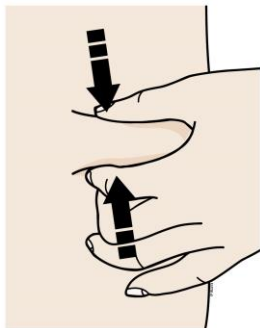

Pinch method

Pinch the skin firmly between your thumb and fingers, creating an area about **five** centimeters wide.

Important: Keep skin stretched or pinched while injecting.

Step 3: Inject

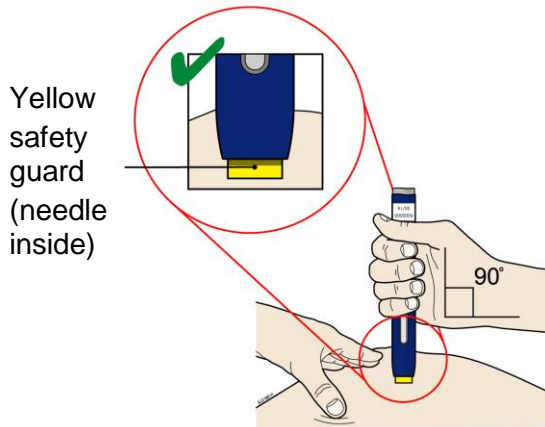

G) Keep holding the stretched or pinched skin. With the orange cap off, **put** the yellow safety guard on the skin at an angle of 90 degrees. The needle is inside the yellow safety guard. Do not touch the grey start button yet.

Push down

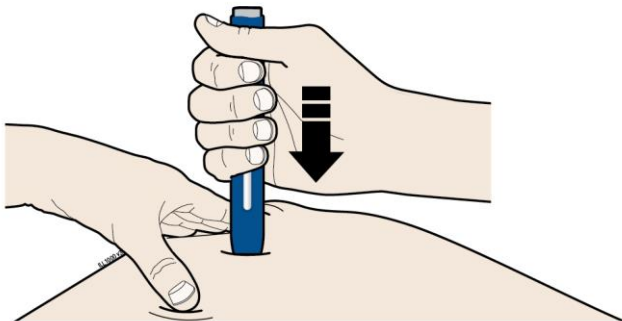

H) Firmly **push** the autoinjector down onto skin until it stops moving.

Important: You must push all the way down but do not touch the grey start button until you are ready to inject.

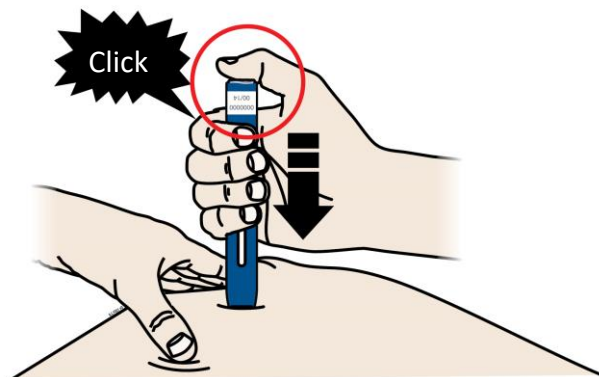

I) When you are ready to inject, **press** the grey start button.

You will hear a click.

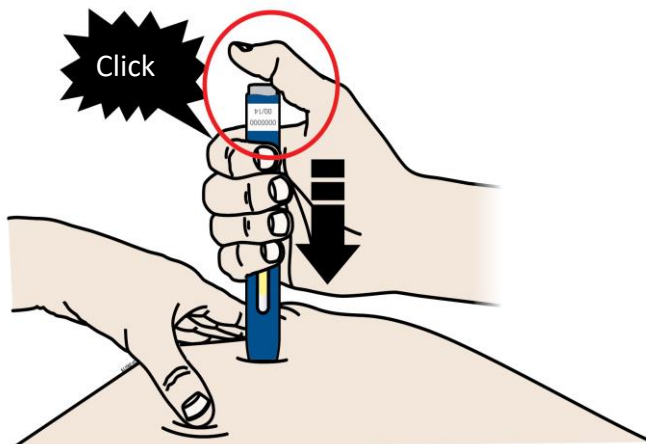

J) Remove your thumb from the button, but keep **pushing** down on the skin. Your injection could take about 15 seconds.



15 seconds

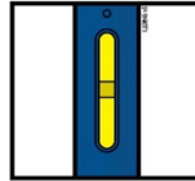

Important: Window turns from clear to yellow when injection is done and you may hear a second click.

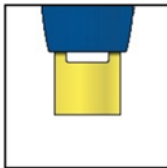

Note: After you remove the autoinjector from your skin, the needle will be automatically covered.

Important: When you remove the autoinjector, if the window has not turned yellow, or if it looks like the medicine is still being released, this means you have not received a full dose. Call your healthcare professional immediately.

Step 4: Finish



K) Discard the used autoinjector and the orange cap.

Put the used SureClick autoinjector in a sharps disposal container right away after use. **Do not** throw away (dispose of) the SureClick autoinjector in your household trash.

- **Do not** reuse the autoinjector.
- **Do not** recycle the autoinjector or sharps disposal container or throw them into household trash.

Important: Always keep the sharps disposal container out of the sight and reach of children.

If you do not have a sharps disposal container, you may use a household container that is:

- Made of a heavy-duty plastic.
- Can be closed with a tight-fitting, puncture-resistant lid, without sharps being able to come out.
- Upright and stable during use.
- Leak-resistant.
- Properly labeled to warn of hazardous waste inside the container.

When your sharps disposal container is almost full, you will need to follow your community guidelines for the right way to dispose of your sharps disposal container. There may be provincial or local laws about how you should throw away used needles and syringes.

L) Examine the injection site.

If there is blood, press a cotton ball or gauze pad on your injection site. **Do not** rub the injection site. Apply an adhesive bandage if needed.

Commonly asked questions

What will happen if I press the grey start button before I am ready to do the injection on my skin?

Even when you press the grey start button, the injection will only happen when the yellow safety guard is also pushed into the autoinjector.

Can I move the autoinjector around on my skin while I am choosing an injection site?

It is okay to move the autoinjector around on the injection site as long as you **do not** press the grey start button. However, if you press the grey start button and the yellow safety guard is pushed into the autoinjector, the injection will begin.

Can I release the grey start button after I start my injection?

You can release the grey start button, but continue to hold the autoinjector firmly against your skin during the injection.

Will the grey start button pop up after I release my thumb?

The grey start button may not pop up after you release your thumb if you held your thumb down during the injection. This is okay.

What do I do if I didn't hear a click after pushing the device down on my skin for 15 seconds?

If you didn't hear a click, you can confirm a complete injection by checking that the window has turned yellow.

Whom do I contact if I need help with the autoinjector or my injection?

If you have any questions about the autoinjector, its storage, or about your injection contact your healthcare professional.