

PATIENT MEDICATION INFORMATION

READ THIS FOR SAFE AND EFFECTIVE USE OF YOUR MEDICINE

PrCOSENTYX®

Secukinumab injection - Solution for injection

Secukinumab for injection - Powder for solution for injection

Read this carefully before you start taking **COSENTYX®** and each time you get a refill. This Patient Medication Information is a summary and will not tell you everything about this drug. Talk to your healthcare professional about your medical condition and treatment and ask if there is any new information about **Cosentyx**.

What is Cosentyx used for?

Cosentyx is used for the treatment of the following inflammatory diseases:

- **Plaque psoriasis**
- **Psoriatic arthritis**
- **Axial spondyloarthritis, including ankylosing spondylitis and non-radiographic axial spondyloarthritis**
- **Juvenile idiopathic arthritis categories: Enthesitis Related Arthritis (ERA) and Juvenile Psoriatic Arthritis (JPsA)**
- **Hidradenitis Suppurativa**

Plaque psoriasis

Cosentyx is used to treat a skin condition called ‘plaque psoriasis’. Plaque psoriasis causes inflammation affecting the skin. Cosentyx will reduce the inflammation and other symptoms of the disease.

Adult

Cosentyx is used in adults with moderate to severe plaque psoriasis.

Pediatrics

Cosentyx is used in patients 6 years and older with moderate to severe plaque psoriasis.

Psoriasis can cause raised, thick, red and scaly patches (“psoriatic lesions”) that can appear anywhere on your body.

Psoriatic arthritis

Cosentyx is used in adults with active psoriatic arthritis and can be used alone or with another medicine called methotrexate. You may first be given other medicines for this disease. If you do not respond well enough to these medicines, you will be given Cosentyx.

The condition is an inflammatory disease of the joints, often accompanied by psoriasis.

Axial spondyloarthritis (axSpA)

Cosentyx is used to treat conditions called ‘ankylosing spondylitis’ and ‘non-radiographic axial

spondyloarthritis'. These are inflammatory disease primarily affecting the spine, which causes inflammation of the spinal joints.

Cosentyx is used in adults with active ankylosing spondylitis and active non-radiographic axial spondyloarthritis.

You (or your child) may first be given other medicines for this disease. If you do not respond well enough to these medicines, you (or your child) will be given Cosentyx.

Juvenile idiopathic arthritis categories: Enthesitis Related Arthritis (ERA) and Juvenile Psoriatic Arthritis (JPsA)

Cosentyx is used to treat the Enthesitis Related (ERA) and Juvenile Psoriatic Arthritis (JPsA) categories of Juvenile Idiopathic Arthritis (JIA) in patients 6 years and older. You (or your child) may first be given other medicines for this disease. If you do not respond well enough to these medicines, you (or your child) will be given Cosentyx.

Hidradenitis Suppurativa

Cosentyx is used to treat a condition called hidradenitis suppurativa, also sometimes called acne inversa or Verneuil's disease. This condition is a chronic and painful inflammatory skin disease that tends to flare. Symptoms may include tender nodules (lumps) and abscesses (boils) that may leak pus. It commonly affects specific areas of the skin, such as the armpits, inner thighs, groin, buttocks and under the breasts. Scarring may also occur in affected areas.

Cosentyx can reduce the number of nodules and abscesses you have and the pain that is often associated with the disease.

Cosentyx is used in adults with hidradenitis suppurativa and can be used alone or with antibiotics.

How does Cosentyx work?

Cosentyx contains the active substance secukinumab. Secukinumab is a fully-human monoclonal antibody. Monoclonal antibodies are proteins that recognize and bind specifically to certain proteins in the body.

Cosentyx belongs to a group of medicines called interleukin (IL) inhibitors. This medicine works by neutralising the activity of a protein called IL-17A, which is present at increased levels in diseases such as psoriasis, psoriatic arthritis, axial spondyloarthritis (including both ankylosing spondylitis and non-radiographic axial spondyloarthritis) and hidradenitis suppurativa. Cosentyx helps reduce the signs and symptoms of psoriasis such as pain, itching, and scaly patches. In addition, Cosentyx helps reduce the signs and symptoms of psoriatic arthritis and axial spondyloarthritis (including both ankylosing spondylitis and non-radiographic axial spondyloarthritis). Cosentyx also helps reduce the number of lumps and boils that may rupture and leak pus in hidradenitis suppurativa. Using Cosentyx in the JIA categories of ERA and JPsA helps reduce the symptoms of your disease. These conditions are inflammatory diseases affecting the joints and the places where tendons join the bone.

If you have any questions about how Cosentyx works or why this medicine has been prescribed for you, ask your healthcare professional.

What are the ingredients in Cosentyx?

Medicinal ingredient: Secukinumab

Non-medicinal ingredients: **Solution for injection:** L-histidine/histidinehydrochloride monohydrate, L-methionine, polysorbate 80, Trehalose dehydrate, water for injection.

Powder for solution for injection*: Sucrose, L-histidine, L-histidine hydrochloride monohydrate, polysorbate 80, water for injection

Cosentyx comes in the following dosage forms:

Solution for injection in a pre-filled syringe (75 mg/0.5 mL), pre-filled syringe (150 mg/mL), pre-filled syringe (300 mg/2mL), pre-filled SensoReady® pen (150 mg/mL) or pre-filled UnoReady™ pen (300 mg/2mL) or single-use vial (lyophilized powder for solution for injection) (150mg)*.

*single-use vial not available in Canada

Do not use Cosentyx if:

- **you (or your child) had a severe allergic** reaction to secukinumab or any of the other ingredients of Cosentyx.
- you think you (or your child) may be allergic, ask your healthcare professional for advice before using Cosentyx.
- you (or your child) have any signs of infection or an active tuberculosis infection unless you are instructed to by your healthcare provider.

To help avoid side effects and ensure proper use, talk to your healthcare professional before you take Cosentyx. Talk about any health conditions or problems you may have, including if:

- you (or your child) currently have an infection or if you have long-term or repeated infections.
- you (or your child) have tuberculosis. Your healthcare professional should check for tuberculosis before starting treatment.
- you (or your child) ever had an allergic reaction to latex. The needle cap on the Cosentyx SensoReady pen and 1mL pre-filled syringe contains a derivative of latex.
- you (or your child) have ever been diagnosed with inflammatory bowel disease (e.g. Crohn's disease or ulcerative colitis). Your healthcare professional should check for signs and symptoms of inflammatory bowel disease.
- you (or your child) had a recent vaccination or if you (or your child) will receive a vaccination during treatment with Cosentyx.

Other warnings you should know about:

Cosentyx is a medicine that affects the immune system.

Cosentyx may increase the risk of having serious side effects such as infections.

You (or your child) have worsening symptoms or develop new symptoms of stomach pain or diarrhea.

Signs or symptoms of a potentially serious infection. These may include:

- fever, flu-like symptoms, muscle aches, night sweats
- feeling tired or short of breath; cough which will not go away
- warm, red and painful skin, or a painful skin rash with blisters
- burning when passing water

Signs or symptoms of an allergic reaction. These may include:

- chest tightness, difficulty breathing or swallowing

- low blood pressure, which can cause dizziness or light-headedness
- swelling of the face, lips, mouth or throat

Do not use Cosentyx if you (or your child) have any signs of infections or an allergic reaction unless you are instructed to by your healthcare provider.

Children and adolescents (below the age of 18 years)

Cosentyx is not recommended for children under 6 years of age with the Enthesitis Related Arthritis (ERA) and Juvenile Psoriatic Arthritis (JPsA) categories of Juvenile Idiopathic Arthritis (JIA).

Cosentyx is not recommended for children under 6 years of age with plaque psoriasis because it has not been studied in this age group.

Cosentyx is not recommended for children and adolescents (under 18 years of age) in other indications because it has not been studied in this age group.

Pregnancy and breast-feeding

Talk to your healthcare professional before using Cosentyx:

- If you (or your child) are pregnant, think that you may be pregnant or are planning to have a baby.
- Cosentyx is not recommended during pregnancy unless the benefits clearly outweigh the potential risks.
- If you (or your child) are breast-feeding or plan to breast-feed.
- It is not known if Cosentyx passes into your breast milk.

Tell your healthcare professional about all the medicines you take, including any drugs, vitamins, minerals, natural supplements or alternative medicines.

The following may interact with Cosentyx:

Tell your healthcare professional:

- If you (or your child) are taking, have recently taken or might take any other medicines.
- If you (or your child) have recently had or are going to have a vaccination. You should not receive certain types of vaccines (live vaccines) while using Cosentyx.

How to take Cosentyx:

Your healthcare provider will prescribe the dose of Cosentyx that is right for you (or your child).

- If the prescribed dose is **75 mg**, administer **1 injection** of Cosentyx 75 mg/0.5mL for each dose.
- If the prescribed dose is **150 mg**, administer **1 injection** of Cosentyx 150 mg/1 mL for each dose.
- If the prescribed dose is **300 mg**, administer **1 injection** of Cosentyx 300 mg/2 mL or **2 injections** of Cosentyx 150 mg/1 mL for each dose.

Always use Cosentyx as your healthcare professional has told you. You should check with your healthcare professional if you are not sure.

Cosentyx is administered via injection under the skin ('subcutaneously').

You and your healthcare professional should decide if you should inject Cosentyx yourself.

It is important not to try to inject yourself (or your child) until you have been trained by your healthcare professional. A caregiver may also give you your Cosentyx injection after proper training.

Usual dose:

Your healthcare professional will decide how much Cosentyx you (or your child) need.

Plaque psoriasis

In adults, the recommended dose is 300 mg by subcutaneous injection with initial dosing at Weeks 0, 1, 2, 3, and 4 followed by monthly maintenance dosing. Further adjustments to your dose may be recommended by your healthcare professional. Each 300 mg dose is given as one subcutaneous injection of 300 mg or as two subcutaneous injections of 150 mg.

In children 6 years and older, the recommended dose is based on body weight and is given by subcutaneous injection with initial dosing at Weeks 0, 1, 2, 3, and 4 followed by monthly maintenance dosing.

For children receiving the 75 mg dose, the 75 mg/0.5mL pre-filled syringe should be used.

Psoriatic arthritis

The recommended dose is 150 mg by subcutaneous injection with initial dosing at Weeks 0, 1, 2, 3, and 4 followed by monthly maintenance dosing.

For psoriatic arthritis patients with coexistent moderate to severe plaque psoriasis, use the dosing and administration recommendations for plaque psoriasis.

For patients who did not respond well to medicines called tumor necrosis factor (TNF) blockers or continues to have active psoriatic arthritis, the 300 mg dose may be given. Each 300 mg dose is given as one subcutaneous injection of 300 mg or as two subcutaneous injections of 150 mg.

Axial spondyloarthritis (axSpA)**Ankylosing spondylitis**

The recommended dose is 150 mg by subcutaneous injection with initial dosing at Weeks 0, 1, 2, 3, and 4 followed by monthly maintenance dosing. Based on your response, your healthcare professional may increase your dose to 300 mg. Each 300 mg dose is given as one subcutaneous injection of 300 mg or two subcutaneous injections of 150 mg.

Non-radiographic axial spondyloarthritis

The recommended dose is 150 mg by subcutaneous injection with initial dosing at Weeks 0, 1, 2, 3, and 4 followed by monthly maintenance dosing.

Enthesitis Related (ERA) and Juvenile Psoriatic Arthritis (JPsA) forms of Juvenile Idiopathic Arthritis (JIA)

In children 6 years and older, the recommended dose is based on body weight and is given by subcutaneous injection at Weeks 0, 1, 2, 3, and 4 followed by monthly maintenance dosing. For patients weighing < 50 kg the dose is 75 mg. For patients weighing ≥ 50 kg the dose is 150 mg. For children receiving the 75 mg dose, the 75 mg/0.5mL pre-filled syringe should be used.

Hidradenitis Suppurativa

The recommended dose is 300 mg by subcutaneous injection with initial dosing at Weeks 0, 1, 2, 3, and 4 followed by an injection every four weeks. Depending on your clinical response, your healthcare professional may increase the frequency of injections to every two weeks.

Each 300 mg dose is given as one subcutaneous injection of 300 mg or two subcutaneous injections of 150 mg.

This is a long-term treatment. Your healthcare professional will regularly monitor your condition to check that the treatment is having the desired effect.

Overdose:

If you accidentally injected more Cosentyx or sooner than according to your healthcare professional's prescription, inform your healthcare professional.

If you think you, or a person you are caring for, have taken too much Cosentyx, contact a healthcare professional, hospital emergency department, or regional poison control centre immediately, even if there are no symptoms.

Missed Dose:

If you have forgotten to inject a dose of Cosentyx, inject the next dose as soon as you remember. Then talk to your healthcare professional to discuss when you should inject the next dose.

Cosentyx solution for injection is a clear liquid. Its color may vary from colorless to slightly yellow. Cosentyx 150 mg/1 mL is available in packs containing 1 or 2 pre-filled syringe(s) or SensoReady pens. Cosentyx 300 mg/2 mL is available in packs containing 1 pre-filled syringe or UnoReady pen.

Instructions for use of the Cosentyx 300 mg pre-filled syringe

Read ALL the way through these instructions before injecting. It is important not to try to inject yourself until you have been trained by your healthcare professional. The box contains one Cosentyx 300 mg pre-filled syringe sealed in a plastic blister.

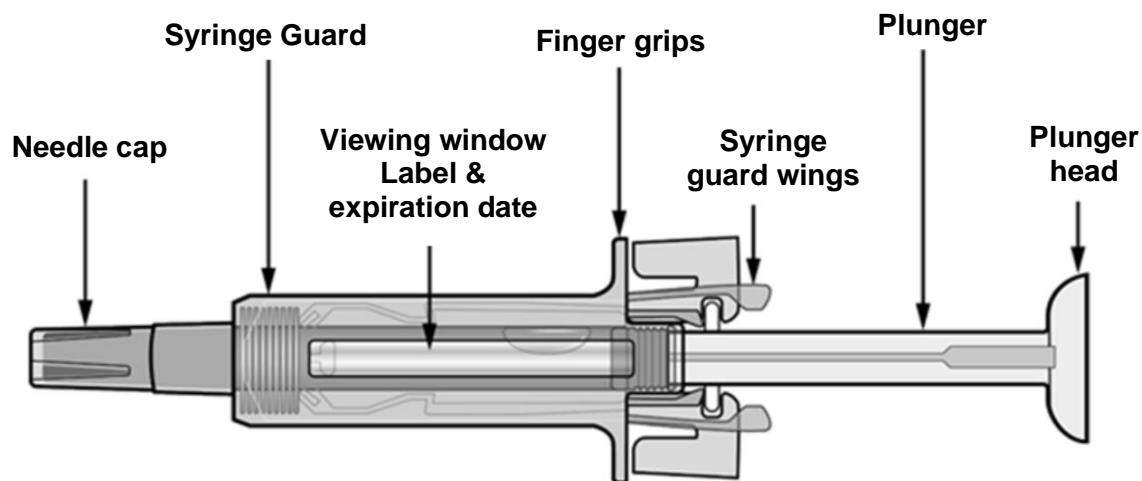
Your Cosentyx 300 mg pre-filled syringe

After the medication has been injected the syringe guard will be activated to cover the needle. This Cosentyx pre-filled syringe is intended to aid in the protection of healthcare professionals, patients who self-inject healthcare professional prescribed medications, and individuals who assist self-injecting patients from accidental needle sticks.

What you additionally need for your injection:

- Alcohol swab.
- Cotton ball or gauze.
- Sharps disposal container.

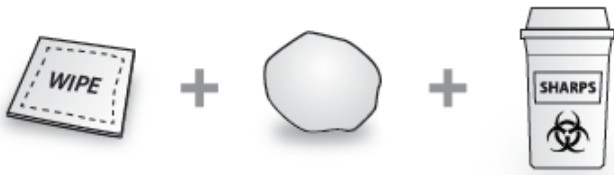

Important safety information

Caution: Keep the Cosentyx 300 mg pre-filled syringe out of the reach of children.

1. Do not open the sealed outer box until you are ready to use the Cosentyx pre-filled syringe.
2. Do not use the Cosentyx pre-filled syringe if either the seal on the outer box or the seal of the blister are broken, as it may not be safe for you to use.
3. Do not use if the syringe has been dropped onto a hard surface or dropped after removing the needle cap.
4. Never leave the Cosentyx pre-filled syringe lying around where others might tamper with it.
5. Do not shake the Cosentyx pre-filled syringe.
6. Be careful not to touch the syringe guard wings before use. By touching them, the syringe guard may be activated too early.
7. Do not remove the needle cap until just before you give the injection.
8. The Cosentyx pre-filled syringe cannot be re-used. Dispose of the used Cosentyx pre-filled syringe immediately after use in a sharps container.

Storage of the Cosentyx 300 mg pre-filled syringe

1. Store the Cosentyx pre-filled syringe sealed in its outer box to protect it from light. Store in the refrigerator between 2°C and 8°C. DO NOT FREEZE.
2. Remember to take the Cosentyx pre-filled syringe out of the refrigerator and allow it to reach room temperature before preparing it for injection (30 to 45 minutes).
3. Do not use the Cosentyx pre-filled syringe after the expiration date shown on the outer box or syringe label. If it has expired, return the entire pack to the pharmacy.

The injection site

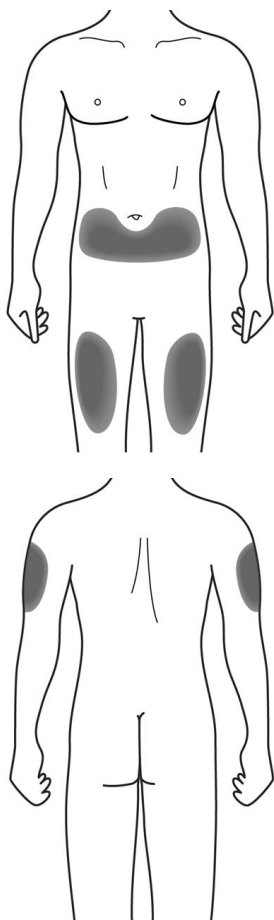

The injection site is the place on the body where you are going to use the Cosentyx pre-filled syringe.

- The recommended site is the front of your thighs. You may also use the lower abdomen, but **not** the area 2 inches (5 cm) around the navel (belly button). If a caregiver is giving you the injection, the outer upper arms may also be used.
- Choose a different site each time you give yourself an injection.
- Do not inject into areas where the skin is tender, bruised, red, scaly or hard. Avoid areas with scars or stretch marks.

Preparing the Cosentyx 300 mg pre-filled syringe ready for use

1. Take the box containing the Cosentyx pre-filled syringe out of the refrigerator and leave it **unopened** for about 30 to 45 minutes so that it reaches room temperature.
2. When you are ready to use the Cosentyx pre-filled syringe, wash your hands thoroughly with soap and water.
3. Clean the injection site with an alcohol swab.
4. Remove the Cosentyx pre-filled syringe from the outer box and take it out of the blister by holding the syringe guard body.
5. Inspect the Cosentyx pre-filled syringe. The liquid should be clear. Its color may vary from colorless to slightly yellow. You may see a small air bubble, which is normal. **DO NOT USE** if the liquid contains easily visible particles, is cloudy or is distinctly brown. **DO NOT USE** if the Cosentyx pre-filled syringe is broken. In all these cases, return the entire product pack to the pharmacy.

How to use the Cosentyx 300 mg pre-filled syringe

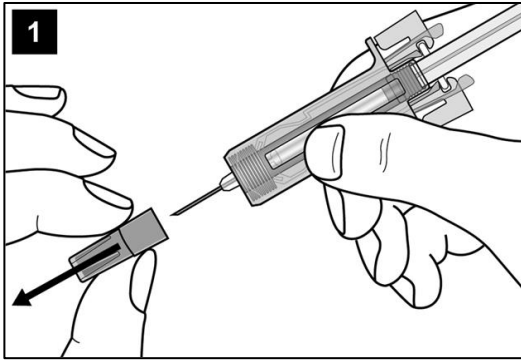

Carefully remove the needle cap from the Cosentyx pre-filled syringe. Discard the needle cap. You may see a drop of liquid at the end of the needle. This is normal.

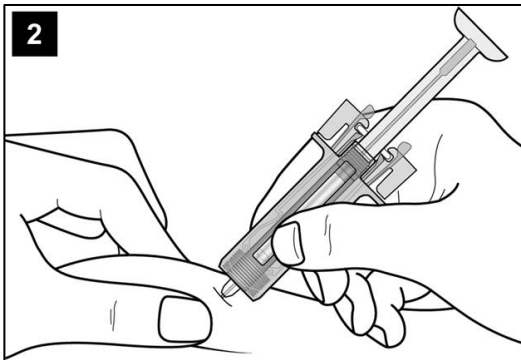

Gently pinch the skin at the injection site and insert the needle as shown. Push the needle all the way in at an angle of approximately 45 degrees to ensure that the medication can be fully administered.

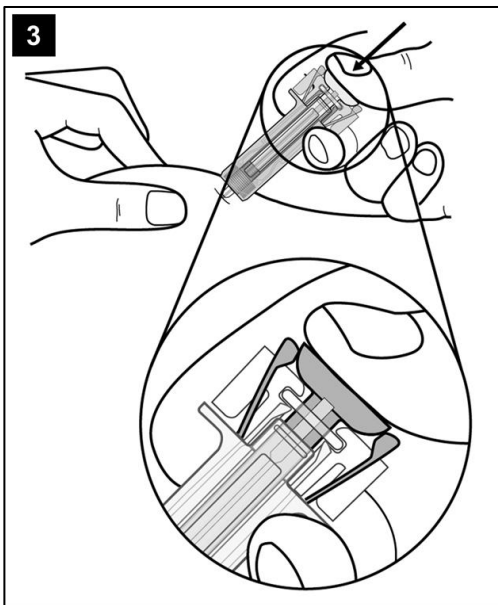

Holding the Cosentyx pre-filled syringe as shown, **slowly** depress the plunger **as far as it will go** so that the plunger head is completely between the syringe guard wings.

Keep the plunger pressed fully down while you hold the syringe in place for 5 seconds.

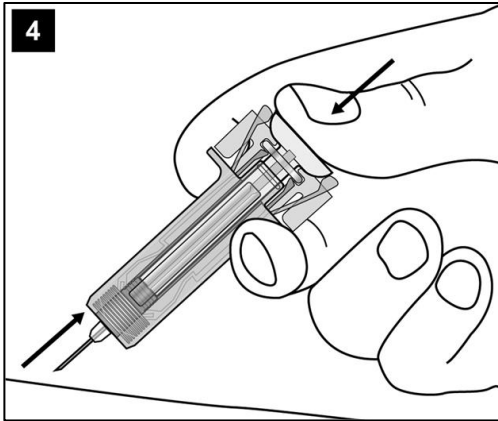

Keep the plunger fully depressed while you carefully lift the needle straight out from the injection site.

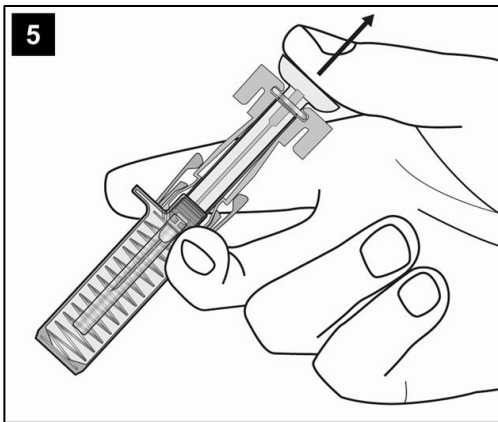

Slowly release the plunger and allow the syringe guard to automatically cover the exposed needle.

There may be a small amount of blood at the injection site. You can press a cotton ball or gauze over the injection site and hold it for 10 seconds. Do not rub the injection site. You may cover the injection site with a small adhesive bandage, if needed.

Disposal instructions



Dispose of the used Cosentyx pre-filled syringe in a sharps container (closable, puncture resistant container). For the safety and health of you and others, needles and used syringes **must never** be re-used.

Instructions for use of the Cosentyx 150 mg pre-filled syringe

Read ALL the way through these instructions before injecting. It is important not to try to inject yourself or a person in your care until you have been trained by your healthcare professional. The box contains 1 or 2 Cosentyx prefilled syringe(s) individually sealed in a plastic blister.

Your Cosentyx 150 mg pre-filled syringe

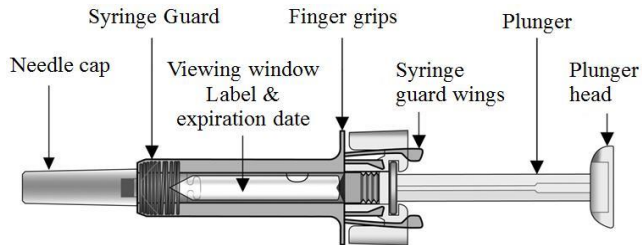

After the medication has been injected the syringe guard will be activated to cover the needle. This Cosentyx pre-filled syringe is intended to aid in the protection of healthcare professionals, patients who self-inject healthcare professional prescribed medications and individuals that assist self-injecting patients from accidental needle sticks.

What you additionally need for your injection:

- Alcohol swab
- Cotton ball or gauze
- Sharps disposal container



Important safety information

Caution: Keep the Cosentyx 150 mg pre-filled syringe out of the reach of children.

1. The needle cap of the syringe may contain dry rubber (latex), which should not be handled by persons sensitive to this substance.
2. Do not open the sealed outer box until you are ready to use the Cosentyx pre-filled syringe.
3. Do not use the Cosentyx pre-filled syringe if either the seal on the outer box or the seal of the blister are broken, as it may not be safe for you to use.
4. Do not use if the syringe has been dropped onto a hard surface or dropped after removing the needle cap.
5. Never leave the Cosentyx pre-filled syringe lying around where others might tamper with it.
6. Do not shake the Cosentyx pre-filled syringe.
7. Be careful not to touch the syringe guard wings before use. By touching them, the syringe guard may be activated too early.
8. Do not remove the needle cap until just before you give the injection.
9. The Cosentyx pre-filled syringe cannot be re-used. Dispose of the used Cosentyx pre-filled syringe immediately after use in a sharps container.

Storage of the Cosentyx 150 mg pre-filled syringe

1. Store the Cosentyx pre-filled syringe sealed in its outer box to protect it from light. Store in the refrigerator between 2°C and 8°C. **DO NOT FREEZE.**
2. Remember to take the Cosentyx pre-filled syringe out of the refrigerator and allow it to reach room temperature before preparing it for injection (15 to 30 minutes).
3. Do not use the Cosentyx pre-filled syringe after the expiration date shown on the outer box or syringe label. If it has expired, return the entire pack to the pharmacy.

The injection site

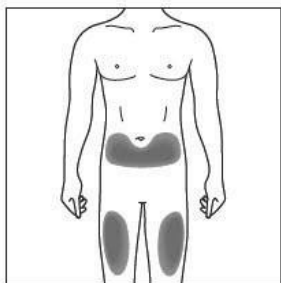

The injection site is the place on the body where you are going to use the Cosentyx pre-filled syringe.

- The recommended site is the front of your thighs. You may also use the lower abdomen, but **not** the area 2 inches (5 cm) around the navel (belly button). If a caregiver is giving you the injection, the outer upper arms may also be used.
- Choose a different site each time you give yourself an injection.
- Do not inject into areas where the skin is tender, bruised, red, scaly or hard. Avoid areas with scars or stretch marks.

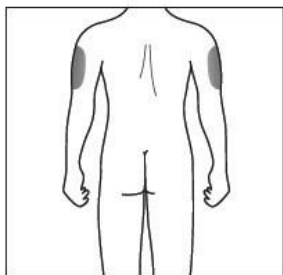

Preparing the Cosentyx 150 mg pre-filled syringe ready for use

Note: for a 150 mg dose, prepare 1 pre-filled syringe and inject the content. For a 300 mg dose, prepare 2 pre-filled syringes and inject the content of both.

1. Take the box containing the Cosentyx pre-filled syringe out of the refrigerator and leave it **unopened** for about 15 to 30 minutes so that it reaches room temperature.
2. When you are ready to use the Cosentyx pre-filled syringe, wash your hands thoroughly with soap and water.
3. Clean the injection site with an alcohol swab.
4. Remove the Cosentyx pre-filled syringe from the outer box and take it out of the blister.
5. Inspect the Cosentyx pre-filled syringe. The liquid should be clear. Its color may vary from colorless to slightly yellow. You may see a small air bubble, which is normal. **DO NOT USE** if the liquid contains easily visible particles, is cloudy or is distinctly brown. **DO NOT USE** if the Cosentyx pre-filled syringe is broken. In all these cases, return the entire product pack to the pharmacy.

How to use the Cosentyx 150 mg pre-filled syringe

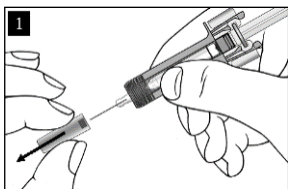

Carefully remove the needle cap from the Cosentyx pre-filled syringe. Discard the needle cap. You may see a drop of liquid at the end of the needle. This is normal.

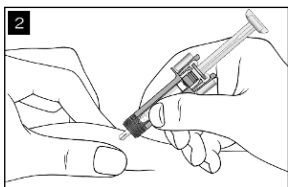

Gently pinch the skin at the injection site and insert the needle as shown. Push the needle all the way in at an angle of approximately 45 degrees to ensure that the medication can be fully administered.

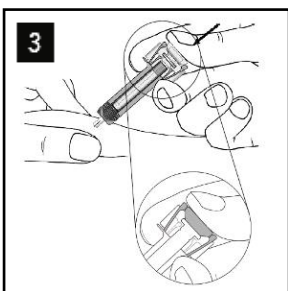

Holding the Cosentyx pre-filled syringe as shown, **slowly** depress the plunger **as far as it will go** so that the plunger head is completely between the syringe guard wings. Keep the plunger pressed fully down while you hold the syringe in place for 5 seconds.

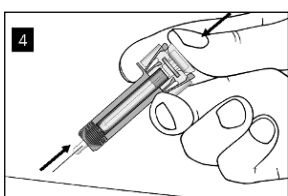

Keep the plunger fully depressed while you carefully lift the needle straight out from the injection site.

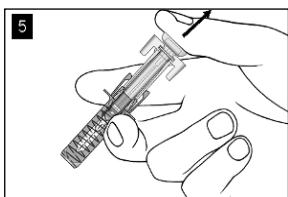

Slowly release the plunger and allow the syringe guard to automatically cover the exposed needle.

There may be a small amount of blood at the injection site. You can press a cotton ball or gauze over the injection site and hold it for 10 seconds. Do not rub the injection site. You may cover the injection site with a small adhesive bandage, if needed.

Disposal instructions

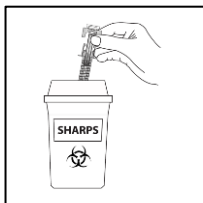

Dispose of the used Cosentyx pre-filled syringe in a sharps container (closable, puncture resistant container). For the safety and health of you and others, needles and used syringes **must never** be re-used.

Instructions for use of the 75 mg Cosentyx pre-filled syringe

Read ALL the way through these instructions before injecting. It is important not to try to inject yourself until you or a person in your care have been trained by your healthcare professional. The box contains one Cosentyx 75 mg pre-filled syringe individually sealed in a plastic blister.

Your Cosentyx 75 mg pre-filled syringe

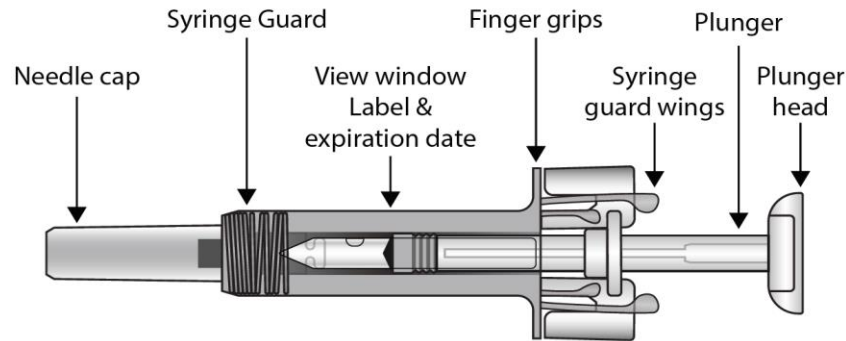

After the medication has been injected the syringe guard will be activated to cover the needle. This Cosentyx pre-filled syringe is intended to aid in the protection of healthcare professionals, patients who self inject healthcare professional prescribed medications, and individuals who assist self injecting patients from accidental needle sticks.

What you additionally need for your injection:

- Alcohol swab
- Cotton ball or gauze
- Sharps disposal container

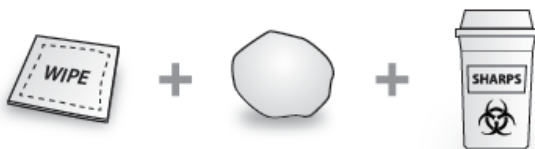

Important safety information

Caution: Keep the Cosentyx 75 mg pre-filled syringe out of the reach of children.

1. The needle cap of the syringe contains dry rubber (latex), which should not be handled by persons sensitive to this substance.
2. Do not open the sealed outer box until you are ready to use the Cosentyx pre-filled syringe.
3. Do not use the Cosentyx pre-filled syringe if either the seal on the outer box or the seal of the blister are broken, as it may not be safe for you to use.
4. Do not use if the syringe has been dropped onto a hard surface or dropped after removing the needle cap.
5. Never leave the Cosentyx pre-filled syringe lying around where others might tamper with it.
6. Do not shake the Cosentyx pre-filled syringe.

7. Be careful not to touch the syringe guard wings before use. By touching them, the syringe guard may be activated too early.
8. Do not remove the needle cap until just before you give the injection.
9. The Cosentyx pre-filled syringe cannot be re-used. Dispose of the used Cosentyx pre-filled syringe immediately after use in a sharps container.

Storage of the Cosentyx 75 mg pre-filled syringe

1. Store the Cosentyx pre-filled syringe sealed in its outer box to protect it from light. Store in the refrigerator between 2°C and 8°C. **DO NOT FREEZE.**
2. Do not use the Cosentyx pre-filled syringe after the expiration date shown on the outer box or syringe label. If it has expired, return the entire pack to the pharmacy.

The injection site

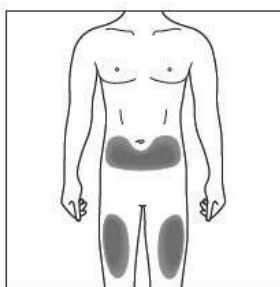

The injection site is the place on the body where you are going to use the Cosentyx pre-filled syringe.

- The recommended site is the front of your thighs. You may also use the lower abdomen, but not the area 2 inches (5 cm) around the navel (belly button). If a caregiver is giving you the injection, the outer upper arms may also be used.
- Choose a different site each time you give yourself an injection.
- Do not inject into areas where the skin is tender, bruised, red, scaly or hard. Avoid areas with scars or stretch marks.

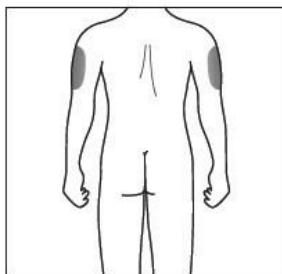

Preparing the Cosentyx 75 mg pre-filled syringe ready for use

1. Take the box containing the Cosentyx pre-filled syringe out of the refrigerator and leave it **unopened** for about 15 to 30 minutes so that it reaches room temperature.
2. When you are ready to use the Cosentyx pre-filled syringe, wash your hands thoroughly with soap and water.
3. Clean the injection site with an alcohol swab.
4. Remove the Cosentyx pre-filled syringe from the outer box and take it out of the blister.
5. Inspect the Cosentyx pre-filled syringe. The liquid should be clear. Its color may vary from colorless to slightly yellow. You may see a small air bubble, which is normal. **DO NOT USE** if the liquid contains easily visible particles, is cloudy or is distinctly brown. **DO NOT USE** if the Cosentyx pre-filled syringe is broken. In all these cases, return the entire product pack to the pharmacy.

How to use the Cosentyx 75 mg pre-filled syringe

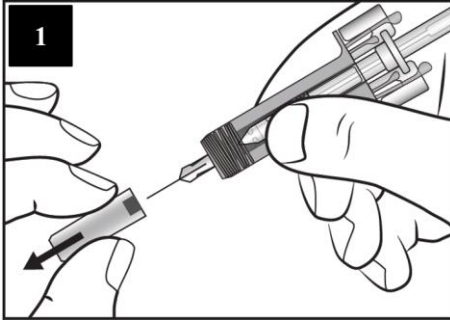

Carefully remove the needle cap from the Cosentyx pre-filled syringe. Discard the needle cap. You may see a drop of liquid at the end of the needle. This is normal.

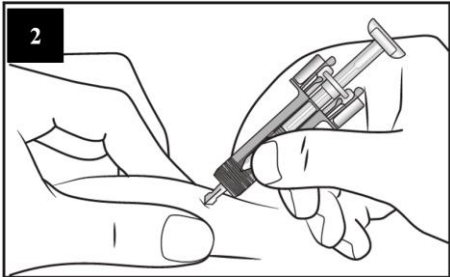

Gently pinch the skin at the injection site and insert the needle as shown. Push the needle all the way in at an angle of approximately 45 degrees to ensure that the medication can be fully administered.

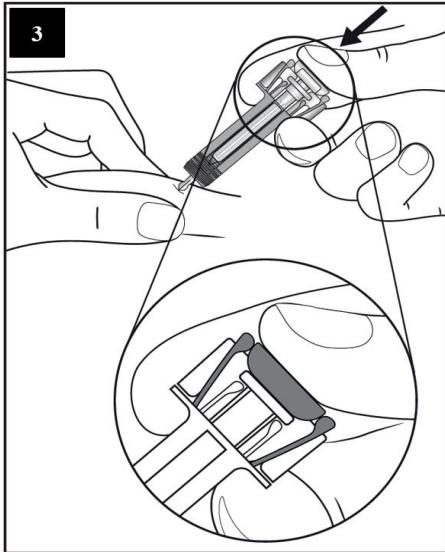

Holding the Cosentyx pre-filled syringe as shown, **slowly** depress the plunger **as far as it will go** so that the plunger head is completely between the syringe guard wings.

Keep the plunger pressed fully down while you hold the syringe in place for 5 seconds.

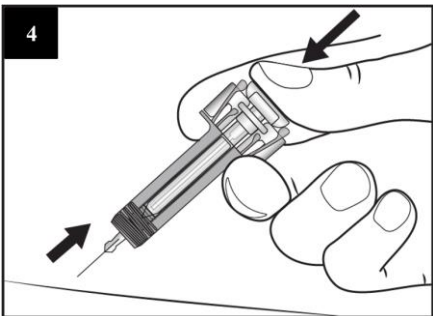

Keep the plunger fully depressed while you carefully lift the needle straight out from the injection site.

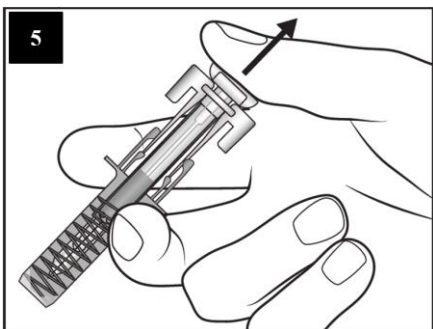

Slowly release the plunger and allow the syringe guard to automatically cover the exposed needle.

There may be a small amount of blood at the injection site. You can press a cotton ball or gauze over the injection site and hold it for 10 seconds. Do not rub the injection site. You may cover the injection site with a small adhesive bandage, if needed.

Disposal instructions

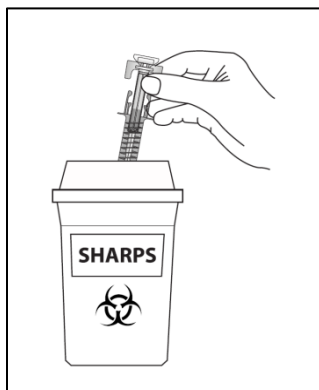

Dispose of the used Cosentyx pre-filled syringe in a sharps container (closable, puncture resistant container). For the safety and health of you and others, needles and used syringes **must never** be re-used.

Instructions for use of Cosentyx 300 mg UnoReady pen

Read ALL the way through these instructions before injecting.

These instructions are to help you to inject correctly using the Cosentyx UnoReady pen.

It is important not to try to inject yourself or a person in your care until you have been trained by your healthcare professional.

Your Cosentyx UnoReady pen 300 mg:

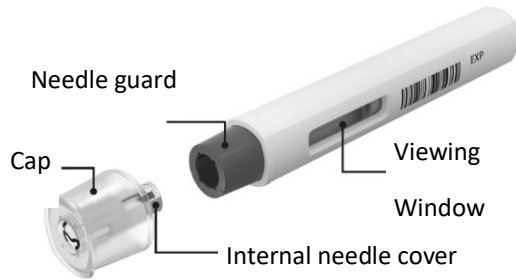

Cosentyx UnoReady pen is shown above with the cap removed. **Do not** remove the cap until you are ready to inject.

Do not use the Cosentyx UnoReady pen if the seal on the outer carton is broken.

Keep the Cosentyx UnoReady pen in the sealed outer carton until you are ready to use it to protect it from light.

Store your Cosentyx UnoReady pen in a **refrigerator** between 2°C and 8°C and **out of the reach of children**.

Do not **freeze** the Cosentyx UnoReady pen.

Do not **shake** the Cosentyx UnoReady pen.

Do not use the Cosentyx UnoReady pen if it has been **dropped** with the cap removed.

The needle is covered by the needle guard and the needle will not be seen. **Do not** touch or push the needle guard because you could get a needle stick.

What you need for your injection:



What you need for your injection:

Included in the carton:

- A new, unused Cosentyx UnoReady pen



Not included in the carton:

- Alcohol swab
- Cotton ball or gauze
- Sharps disposal container

See “**How should I dispose of used Cosentyx UnoReady pens?**” at the end of this Instructions for Use.

Before your injection:

For a more comfortable injection, take the Cosentyx UnoReady pen out of the refrigerator **30 to 45 minutes before injecting** to allow it to reach room temperature.

1. Important safety checks before you inject:

For the “viewing window”:



Viewing window Expiration date (EXP)

The liquid should be clear. Its color may vary from colorless to slightly yellow.

Do not use if the liquid contains visible particles, is cloudy or is distinctly brown. You may see air bubbles, which is normal.

For the “Expiration date”:

Look at the expiration date (EXP) on your Cosentyx pen. **Do not use** the pen if the **expiration date** has passed.

Check that your pen contains the correct medicine and dosage.

Contact your pharmacist if the pen fails any of these checks.

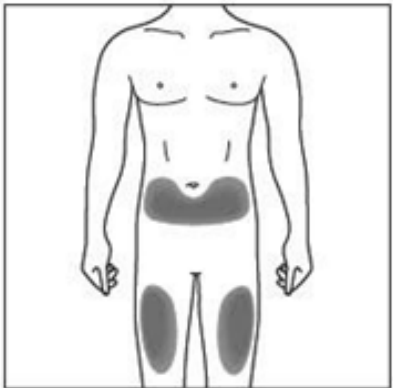

2a. Choose your injection site:

- The recommended site is the front of the thighs. You may also use the lower abdomen, but **not** the area 2 inches (5 cm) around the navel (belly button).
- Choose a different site each time you give yourself an injection.
- Do not inject into areas where the skin is tender, bruised, red, scaly or hard. Avoid areas with scars or stretch marks.

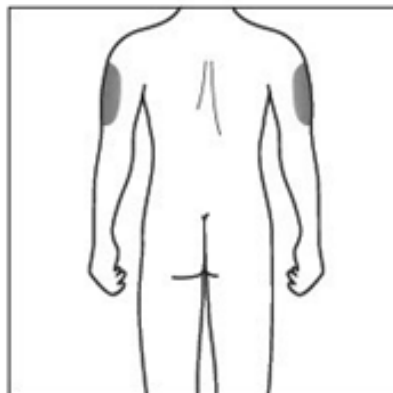

2b. Caregivers and healthcare professionals only:

- If a **caregiver** or **healthcare professional** is giving you your injection, they may also inject into your outer upper arm.



3. Cleaning your injection site:

- Wash your hands with soap and hot water.
- Using a circular motion, clean the injection site with the alcohol swab. Leave it to dry before injecting.
- Do not touch the cleaned area again before injecting.

Your injection:

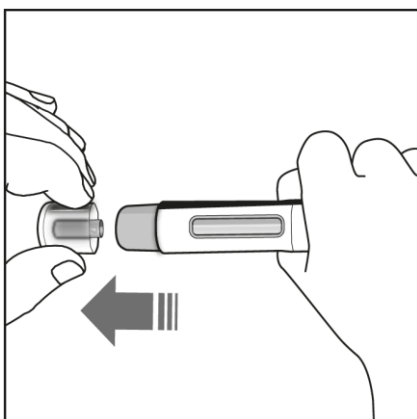

4. Removing the cap:

- Only remove the cap when you are ready to use the pen.
- Pull the cap straight off in the direction of the arrow that is shown in the figure on left.
- Once removed, throw away the cap. **Do not try to reattach the cap** as you may bend the needle.
- Use the pen within 5 minutes of removing the cap.

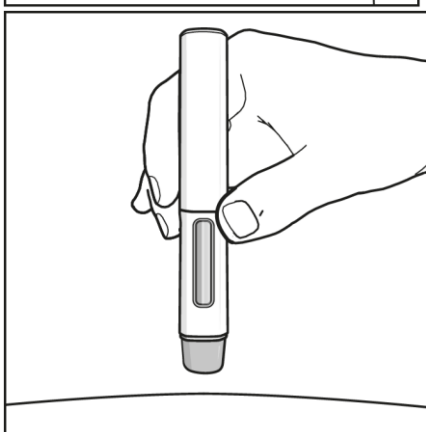

5. Holding your Cosentyx UnoReady pen:

- Hold the pen at 90 degrees to the cleaned injection site.

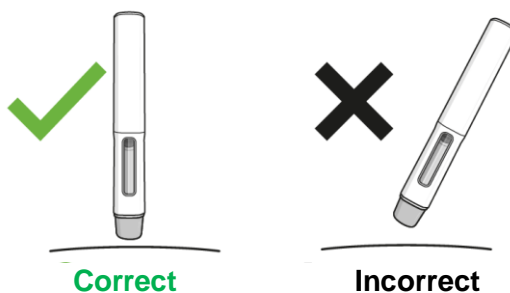

YOU MUST READ THIS BEFORE INJECTING.

During the injection you will hear 2 clicks.

The 1st click indicates that the injection has started. Several seconds later a 2nd click will indicate that the injection is almost finished.

You must keep holding the pen firmly against your skin until you see a green indicator with a grey tip fill the window and stop moving.

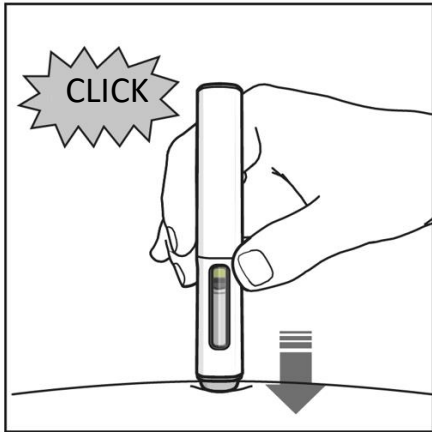

6. Starting your injection:

- Press the pen firmly against the skin to start the injection.
- The **1st click** indicates the injection has started.
- **Keep holding** the pen firmly against your skin.
- The **green indicator with the grey tip** shows the progress of the injection.

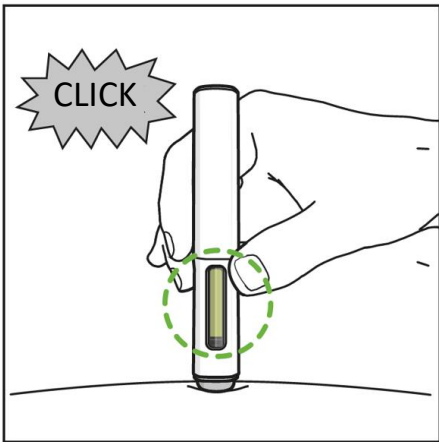

7. Completing your injection:

- Listen for the **2nd click**. This indicates the injection is **almost** complete.
- Check the **green indicator with the grey tip** has filled the window and has stopped moving.
- The pen can now be removed

After your injection:

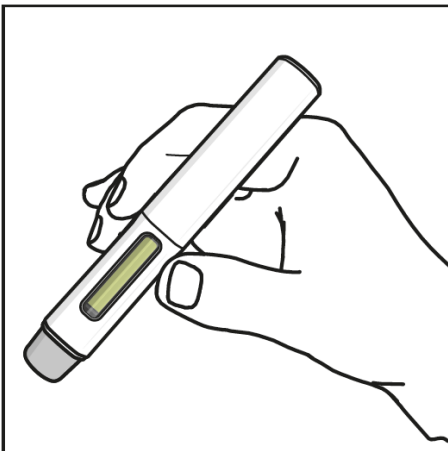

8. Check the green indicator fills the window:

- This means the medicine has been delivered. Contact your healthcare professional if the green indicator is not visible.
- There may be a small amount of blood at the injection site. You can press a cotton ball or gauze over the injection site and hold it for 10 seconds. Do not rub the injection site. You may cover the injection site with a small adhesive bandage, if needed.

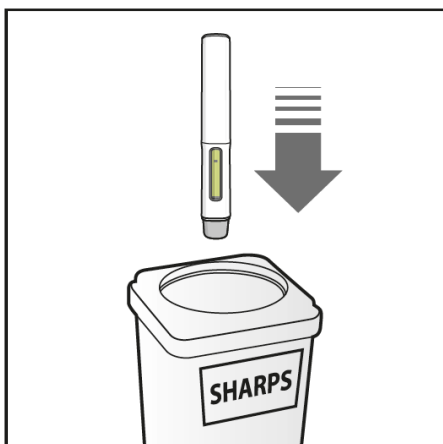

9. Disposing of your Cosentyx UnoReady pen:

- Dispose of the used pen in a sharps disposal container (i.e. a punctureresistant closable container, or similar).
- Never try to reuse your pen.

Instructions for use of Cosentyx 150 mg SensoReady pen

Read ALL the way through these instructions before injecting.

These instructions are to help you to inject correctly using the Cosentyx SensoReady pen.

It is important not to try to inject yourself or a person in your care until you have been trained by your healthcare professional.

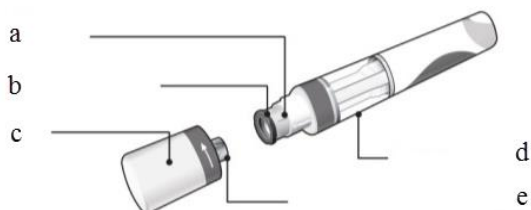

- a. Needle
- b. Needle guard
- c. Cap
- d. Inspection window
- e. Internal needle cover

Cosentyx SensoReady pen shown with the cap removed. **Do not** remove the cap until you are ready to inject.

Store your boxed Cosentyx SensoReady pen in a **refrigerator** between 2°C and 8°C and **out of the reach of children**.

Do not **freeze** the Cosentyx SensoReady pen.

Do not **shake** the Cosentyx SensoReady pen.

Do not use the Cosentyx SensoReady pen if it has been **dropped** with the cap removed.

For a more comfortable injection, take the Cosentyx SensoReady pen out of the refrigerator **15 to 30 minutes before injecting** to allow it to reach room temperature.

What you need for your injection:

Included in the carton:

- A new and unused Cosentyx SensoReady pen.
1 pen is needed for a 150 mg dose and 2 pens are needed for a 300 mg dose.

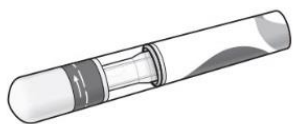

Not Included in the carton:

- Alcohol swab
- Cotton ball or gauze
- Sharps disposal container



Before your injection

1. Important safety checks before you inject:

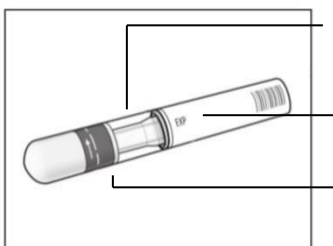

- The liquid should be clear. Its color may vary from colorless to slightly yellow.
- **Do not use** if the liquid contains easily visible particles, is cloudy or is distinctly brown. You may see a small air bubble, which is normal.
- **Do not use** your Cosentyx SensoReady pen if the **expiration date** has passed.
- **Do not use** if the **safety seal** has been broken.
- Contact your pharmacist if the Cosentyx SensoReady pen fails any of these checks.

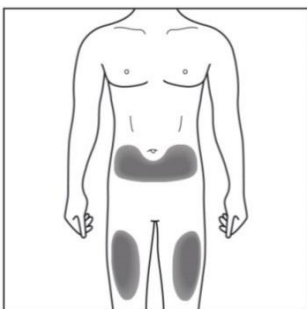

2a. Choose your injection site:

- The recommended site is the front of the thighs. You may also use the lower abdomen, but not the area 2 inches around the navel (belly button).
- Choose a different site each time you give yourself an injection.
- Do not inject into areas where the skin is tender, bruised, red, scaly or hard. Avoid areas with scars or stretch marks.

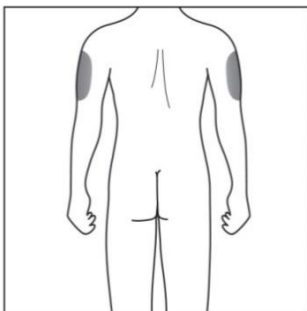

2b. Caregivers and Healthcare Professionals Only:

If a **caregiver** or **healthcare professional** is giving you your injection, they may also inject into your outer upper arm.



3. Cleaning your injection site:

- Wash your hands with hot soapy water.
- Using a circular motion, clean the injection site with the alcohol swab. Leave it to dry before injecting.
- Do not touch the cleaned area again before injecting.

Your injection

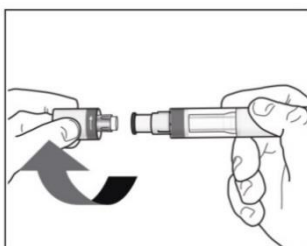

4. Removing the cap:

- Only remove the cap when you are ready to use the Cosentyx SensoReady pen.
- Twist off the cap in the direction of the arrows.
- Once removed, throw away the cap. **Do not try to re-attach the cap.**
- Use the Cosentyx SensoReady pen within 5 minutes of removing the cap.

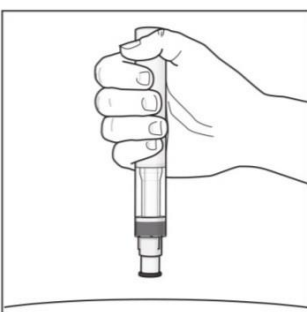

5. Holding your Cosentyx SensoReady pen:

- Hold the Cosentyx SensoReady pen at 90° to the cleaned injection site.

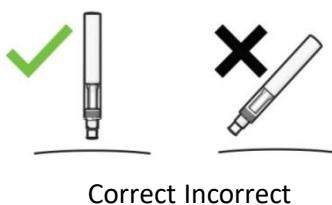

Correct Incorrect

YOU MUST READ THIS BEFORE INJECTING.

During the injection you will hear **2 loud clicks**.

The **1st click** indicates that the injection has started. Several seconds later a **2nd click** will indicate that the injection is **almost** finished.

You must keep holding the Cosentyx SensoReady pen firmly against your skin until you see a **green indicator** fill the window and stop moving.

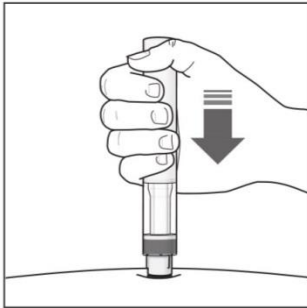

6. Starting your Injection:

- Press the Cosentyx SensoReady pen firmly against the skin to start the injection.
- **The 1st click** indicates the injection has started.
- **Keep holding** the Cosentyx SensoReady pen firmly against your skin.
- The **green indicator** shows the progress of the injection.

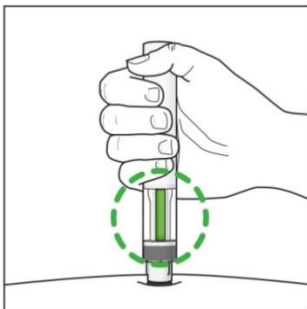

7. Completing your injection:

- Listen for the **2nd click**. This indicates the injection is **almost** complete.
- Check the **green indicator** fills the window and has stopped moving.
- The Cosentyx SensoReady pen can now be removed.

After your injection

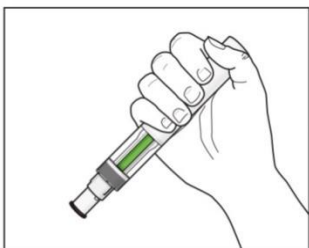

8. Check the green indicator fills the window:

- This means the medicine has been delivered. Contact your healthcare professional if the green indicator is not visible.
- There may be a small amount of blood at the injection site. You can press a cotton ball or gauze over the injection site and hold it for 10 seconds. Do not rub the injection site. You may cover the injection site with a small adhesive bandage, if needed.

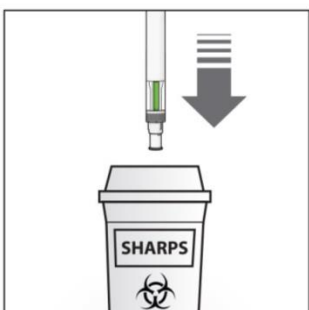

9. Disposing of your Cosentyx SensoReady pen:

- Dispose of the used Cosentyx SensoReady pen in a sharps disposal container (i.e. a puncture-resistant closable container, or similar).
- Never try to reuse your Cosentyx SensoReady pen.

Instructions for use of COSENTYX powder for solution for injection*

*single-use vial not available in Canada

The following information is intended for medical or healthcare professionals only.

Store the vial of 150 mg powder for solution for injection of COSENTYX in the refrigerator between 2°C to 8°C.

The single-use vial contains 150 mg of COSENTYX for reconstitution with sterile water for injection (SWFI). Do not use the vial after the expiry date shown on the outer box or vial. If it has expired, return the entire pack to the pharmacy.

The preparation of the solution for subcutaneous injection shall be done without interruption ensuring that aseptic technique is used. The preparation time from piercing the stopper until end of reconstitution on average takes 20 minutes and should not exceed 90 minutes.

To prepare COSENTYX 150 mg powder for solution for injection please adhere to the following instructions:

Instructions for reconstitution of COSENTYX 150 mg powder for solution for injection:

1. Bring the vial of COSENTYX 150 mg powder for solution for injection to room temperature and ensure sterile water for injection (SWFI) is at room temperature.
2. Withdraw slightly more than 1.0 mL sterile water for injection (SWFI) into a 1 mL graduated disposable syringe and adjust to 1.0 mL.
3. Remove the plastic cap from the vial.

4. Insert the syringe needle into the vial containing the lyophilized cake of COSENTYX through the center of the rubber stopper and reconstitute the cake by slowly injecting 1.0 mL of SWFI into the vial. The stream of SWFI should be directed onto the lyophilized cake.



5. Tilt the vial to an angle of approx. 45° and gently rotate between the fingertips for approx. 1 minute. Do not shake or invert the vial.



6. Keep the vial standing at room temperature for a minimum of 10 minutes to allow for dissolution. Note that foaming of the solution may occur.
7. Tilt the vial to an angle of approx. 45° and gently rotate between the fingertips for approx. 1 minute. Do not shake or invert the vial.



8. Allow the vial to stand undisturbed at room temperature for approximately 5 minutes. The resulting solution should be clear. Its color may vary from colorless to slightly yellow. Do not use if the lyophilized powder has not fully dissolved or if the liquid contains easily visible particles, is cloudy or is distinctly brown.
9. Prepare the required number of vials (1 vial for the 75 mg dose, 1 vial for the 150 mg dose, 2 vials for the 300 mg dose).

After preparation, the solution for subcutaneous injection can be used immediately or can be stored at 2°C to 8°C for up to 24 hours. Do not freeze. After storage at 2°C to 8°C, the solution should be allowed to come to room temperature for approximately 20 minutes before administration. The solution should be administered within 1 hour after removal from the 2°C to 8°C storage.

Instructions for administration of COSENTYX solution

1. Tilt the vial to an angle of approximately 45° and position the needle tip at the very bottom of the solution in the vial when drawing the solution into the syringe. DO NOT invert the vial.

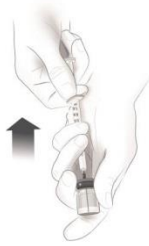

2. For the 150mg and 300 mg doses, carefully withdraw slightly more than 1.0 mL of the solution for subcutaneous injection from the vial into a 1 mL graduated disposable syringe using a suitable needle (e.g. 21G x 2"). This needle will only be used for withdrawing COSENTYX into the disposable syringe. Prepare the required number of syringes (2 syringes for the 300 mg dose). For a child receiving the 75 mg dose, carefully withdraw slightly more than 0.5 mL of the solution for subcutaneous injection and discard the rest immediately.
3. With the needle pointing upward, gently tap the syringe to move any air bubbles to the top.



4. Replace the attached needle with a 27G x ½" needle.



5. Expel the air bubbles. For the 150 mg dose, and advance the plunger to the 1.0 mL mark. For the 75 mg dose, advance the plunger to the 0.5 mL mark.
6. Clean the injection site with an alcohol swab.
7. Inject the COSENTYX solution subcutaneously into the front of thighs, lower abdomen (but **not** the area 2 inches (5 centimeters) around the navel (belly button) or outer upper arms. Choose a different site each time an injection is administered. Do not inject into areas where the skin is tender, bruised, red, scaly or hard. Avoid areas with scars or stretch marks.

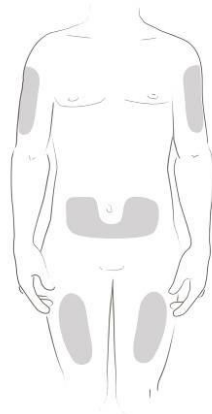

8. Any remaining solution in the vial must not be used and should be discarded in accordance with local requirements. Vials are for single use only. Dispose of the used syringe in a sharps container (closable, puncture resistant container). For the safety and health of you and others, needles and used syringes **must never** be re-used.

What are possible side effects from using Cosentyx?

These are not all the possible side effects you may have when taking Cosentyx. If you experience any side effects not listed here, tell your healthcare professional.

As with all medicines, patients treated with Cosentyx may experience side effects.

STOP using Cosentyx and seek medical help immediately if you experience any of the following, which are signs of an allergic reaction:

- difficulty breathing or swallowing
- swelling of the face, lips, tongue or throat
- severe itching of the skin, with a red rash or raised bumps

Possible side effects

Side effects include the following listed below. Most of the side effects are mild to moderate. If these side effects become severe, please tell your healthcare professional.

Some side effects are very common *(These side effects may affect more than 1 in 10 people)*

- Upper respiratory tract infections with symptoms such as sore throat and stuffy nose (nasopharyngitis, rhinitis)

Some side effects are common *(These side effects may affect up to 1 in every 10 people)*

- Cold sores (oral herpes)
- Diarrhea
- Itchy rash (urticaria)
- Runny nose (rhinorrhea)

Some side effects are uncommon *(These side effects may affect up to 1 in every 100 people)*

- Oral thrush (oral candidiasis)
- Signs of low levels of white blood cells such as fever, sore throat or mouth ulcers due to infections (neutropenia)

- Athlete’s foot (tinea pedis)
- Discharge from the eye with itching, redness and swelling (conjunctivitis)
- Nausea, diarrhea, vomiting, abdominal pain and fever (symptoms of inflammatory bowel disease)
- Small, itchy blisters on the palms of hands, soles of feet and edges of the fingers and toes (dyshidrotic eczema)

Not known (*frequency cannot be estimated from available data*)

- Fungal infections of the skin and mucous membranes (thrush)
- Inflammation of small blood vessels, which can lead to a skin rash with small red or purple bumps (vasculitis)
- Painful swelling and skin ulceration (pyoderma gangrenosum)

If you notice any side effects not listed in this Patient Medication Information, please inform your healthcare professional.

Serious side effects and what to do about them			
Symptom / effect	Talk to your healthcare professional		Stop taking drug and get immediate medical help
	Only if severe	In all cases	
RARE			
Serious allergic reactions		√	√
Serious infections		√	

If you have a troublesome symptom or side effect that is not listed here or becomes bad enough to interfere with your daily activities, tell your healthcare professional.

Reporting Side Effects

You can report any suspected side effects associated with the use of health products to Health Canada by:

- Visiting the Web page on Adverse Reaction Reporting (<https://www.canada.ca/en/health-canada/services/drugs-health-products/medeffect-canada.html>) for information on how to report online, by mail or by fax; or
- Calling toll-free at 1-866-234-2345.

NOTE: Contact your health professional if you need information about how to manage your side effects. The Canada Vigilance Program does not provide medical advice.

Storage:

- Store Cosentyx pre-filled syringe or SensoReady or UnoReady pens sealed in its box to protect from light.
- Store in the refrigerator between 2°C and 8°C. DO NOT FREEZE.
- Do not shake.

- If necessary, the pre-filled syringe and the pen may be stored unrefrigerated for a single period of up to 4 days at room temperature, not above 30°C. Discard the pre-filled syringe or pen after 4 days if left unrefrigerated.

Do not use Cosentyx pre-filled syringe or SensoReady or UnoReady pens:

- After the expiration date shown on the outer box or the label on the syringe or pen.
- If the liquid contains easily visible particles, is cloudy or is distinctly brown.

Any unused product or waste material should be disposed of in accordance with local requirements. Ask your pharmacist how to dispose of medicines you no longer use.

Keep out of reach and sight of children.

If you want more information about Cosentyx:

- Talk to your healthcare professional
- Find the full product monograph that is prepared for healthcare professionals and includes this Patient Medication Information by visiting the Health Canada website: (<https://www.canada.ca/en/health-canada/services/drugs-health-products/drug-products/drug-product-database.html>); the manufacturer's website <http://www.novartis.ca>, or by calling 1-800-363-8883 number.

This Patient Medication Information was prepared by Novartis Pharmaceuticals Canada Inc.

Last Revised: MAY 17, 2024

Cosentyx and SensoReady are registered trademarks.

UnoReady is a trademark.